

Tecomat Foxtrot

CFox

RFox



## Product Catalog



## Dear customers, dear designers!

You get into the hand the new issue of the catalog of programmable controllers produced by Teco a.s. company.

This catalog is dedicated to PLC system Tecomat Foxtrot designed for any application in industry, transport, measurement and energy control etc.

Foxtrot system is younger and smaller brother of time-proven big modular system Tecomat TC700. But smaller dimensions doesn't mean smaller range of functionality. On the other way, you may find in it all functions of big programmable controllers with IEC EN 61131 standard compatibility, even combined with latest technologies known better from IT, telecommunication and internet.





In next section you may find data sheets of CFox modules, these are a logical extension of Foxtrot system into field of intelligent building control and building management systems. They are based on connection via two-wires bus with free topology CIB. CIB – Common Installation Bus is a proprietary bus of Teco a.s. and is patented.

Next section is RFox line, what is a system extension of Tecomat Foxtrot with wireless input/output modules in frequency band 868 MHz.



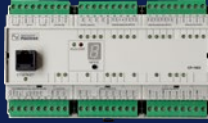

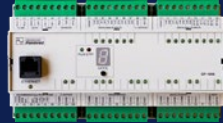
We are sure that product range in this catalog may successfully cover each automation project.

# Central modules, peripheral modules and accessories overview

## Central modules Foxtrot









CP-1000	CP-1003	CP-1004	CP-1005	CP-1006	CP-1008
					
TXN 110 00 4 AI/DI, 2 DI/230 2 RO Page 10	TXN 110 03 8 DI/HSC, 8 AI/DI 4 DO/PWM, 8 RO Page 12	TXN 110 04 4 DI/HSC, 4 DI/AI 6 RO Page 14	TXN 110 05 6 AI/DI 6 RO, 2 AO Page 16	TXN 110 06 13 AI/DI, 1 DI/HSC, 1 DI/230 10 RO, 2 SSR, 2 AO Page 18	TXN 110 08 10 AI/DI, 2 AI, 1 DI/230 7 RO, 4 SSR, 4 RO Page 20

## Central modules Foxtrot with LCD and keyboard

CP-1014	CP-1015	CP-1016	CP-1018
			
TXN 110 14 4 DI/HSC, 4 DI/AI 6 RO Page 14	TXN 110 15 6 AI/DI 6 RO, 2 AO Page 16	TXN 110 16 13 AI/DI, 1 DI/HSC, 1 DI/230 10 RO, 2 SSR, 2 AO Page 18	TXN 110 18 10 AI/DI, 2 AI, 1 DI/230 7 RO, 4 SSR, 4 RO Page 20









## Expansion I/O modules

## Input/output submodules











IB-1301	OS-1401	IR-1501	IT-1604	IT-1602	OT-1651	PX-7811	PX-7812
							
TXN 113 01 4DI/HSC, 8DI Page 24	TXN 114 01 12 DO Page 25	TXN 115 01 4DI/HSC 8 RO Page 26	TXN 116 04 8 AI 2 AO Page 27	TXN 116 02 8 AI (TC) 2 AO Page 27	TXN 116 51 4AO Page 28	TXN 178 11 7 DI Page 31	TXN 178 12 4 DI 3DO Page 31

## Communication modules on TCL2 bus

## Modules connected via serial port

UC-1203	UC-1204	KB-0552	RF-1131	CF-1141	UC-1205	SX-1181	SMM-33
							
TXN 112 03 OpenTherm Page 32	TXN 112 04 MP-Bus Page 32	TXN 105 52 RS-485/ MM optic fiber Page 33	TXN 111 31 RFox master Page 83	TXN 111 41 Bus master 2x CIB Page 47	TXN 112 05 GSM gate for SMS Page 33	TXN 111 81 RS-232 <-> Mbus Page 38	SMM-33 3 phase network measurement/Modbus Page 39





## Communication submodules

MR-0104	MR-0114	MR-0124	MR-0105	MR-0106	MR-0115	MR-0152	MR-0161	MR-0158	MX-0301
									
TXN 101 04 RS-232 Page 30	TXN 101 14 RS-485 Page 30	TXN 101 24 RS-422 Page 30	TXN 101 05 2x RS-232 1x RS-485 Page 30	TXN 101 06 1x RS-232 2x RS-485 Page 30	TXN 101 15 3x RS-485 Page 30	TXN 101 52 Profibus DP Slave Page 30	TXN 101 61 CAN Page 30	TXN 101 58 M bus Page 30	TXN 103 01 Wiegand Page 30







AI – analog input, DI – digital input, AI/DI – combined analog/digital input, DI/230 – digital input 230 VAC, DI/HSC – digital input/fast counter, RTD – resistive temperature detector, thermocouples connection  
AO – analog outputs, DO – digital outputs, RO – relay outputs, SSR – Solid state relay, OC – open collector







## Power supplies

DR-15-24	DR-60-24	DR-100-24	PS2-60/27
			
DR-15-24 24 VDC/0,63 A Page 97	DR-60-24 24 VDC/2,5 A Page 97	DR-100-24 24 VDC/4,2 A Page 97	TXN 070 40 27 VDC/2,2 A 12 VDC/0,3 A Page 96

## Communication Ethernet/GSM









SX-1162	105FX	306FX2	UR5i v2	ER75i v2	RWEPA	Easy Route
						
TXN 111 62 Ethernet switch 5 TX, 100Mbit Page 35	105FX Ethernet switch 4 TX, 1 FX port Page 36	306FX2 Ethernet switch 4 TX, 2 FX port Page 36	UR5i v2 3G/UMTS router	ER75i v2 GPRS/EDGE router	RWEPA WiFi klient IP67	Easy Route 4 TX port, WiFi 3G router

## Displays, HMI panels







ID-18	ID-18 - Design	ID-28	ID-14	ID-17
				
TXN 054 39 Ethernet VGA touch panel Page 41	<b>NEW</b> TXN 054 42 Ethernet VGA touch panel Page 40	TXN 054 40 Ethernet VGA touch panel Page 41	TXN 054 33 bus TCL2 4×20 characters, 25 keys Page 43	TXN 054 37 bus TCL2 240×64 pixels, 4 DI, 2 RO Page 42

## CIB bus system modules



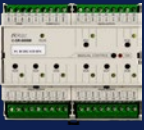



## CIB bus modules on DIN rail

CF-1141	C-BS-0001M	DTNVEM-1/CIB	DTNVE-1/CIB	C-IB-1800M	C-IR-0203M	C-DL-0064M	C-FC-0024X
							
TXN 111 41 Master bus 2× CIB Page . 47	TXN 133 55 Bus separator bus CIB Page . 47	DTNVEM-1/CIB Overvoltage protection CIB Page 48	DTNVE-1/CIB Overvoltage protection CIB Page 48	<b>NEW</b> TXN 133 06 4 AI/DI, 14 DI Page 49	<b>NEW</b> TXN 133 59 2× DI/AI, 2× RO 1× AO/PWM Page 50	<b>NEW</b> TXN 133 54 64x DALI Page 57	TXN 133 39 3 AI/DI 2 RO, 1 AO Page 58

## CIB bus modules on DIN rail

C-HM-0308M	C-HM -1113M	C-HM-1121M	C-OR-0008M	C-DM-0006M-ULED	C-DM-0006M-ILED	C-DM-0402M
						
TXN 133 24 3 AI/DI 6 RO, 2 AO Page 52	TXN 133 10 3 AI, 8 DI 11 RO, 2 AO Page 52	TXN 133 11 3 AI, 8 DI 19 RO, 2 AO Page 52	TXN 133 03 8 RO Page 51	TXN 133 45 6 LED outputs Page 54	TXN 133 46 6 LED outputs Page 55	<b>NEW</b> TXN 133 58 2× 230 V/AC dimmer Page 56

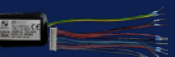

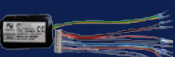

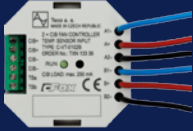

## CIB modules into installation box, under device cover

C-IT-0200S	C-IR-0202S	C-IT-0504S	C-IT-0908S	C-RI-0401S	C-DL-0012S	C-WG-0503S
						
TXN 133 29 2 AI/DI Page 59	TXN 133 25 2 AI/DI 1 RO, 1 AO Page 59	TXN 133 26 5 AI/DI 4 AO Page 60	TXN 133 52 6 DI, 2 AI/DI, 1 AI 8 OC PNP/NPN Page 61	TXN 133 47 2 AI/DI, 1 IR, 1 photodiode 1 IR transmitter Page 62	TXN 133 23 12× DALI Page 63	TXN 133 53 3 DI, 2 AI/DI 3 OC NPN Page 64

CIB modules into installation box, under device cover





C-OR-0202B	C-VT-0102B		
			
TXN 133 02 2 AI/DI 2 RO Page 65	TXN 133 55 1 AI/DI 2 fans ±(7-15)V Page 66		

CIB modules for interior







C-WS-0200R	C-WS-0400R	C-IT-0200R	C-RI-0401R	C-RC-0002R	C-RC-0003R Logus	RCM2-01
						
TXN 133 30 2 Buttons 2×RTD external Page 75	TXN 133 31 4 Buttons 2 RTD external Page 75	TXN 133 19 1 RTD internal 1 RTD external Page 79	TXN 133 2 AI/DI, 1 IR, 1 fotodiode 1 IR transmitter Page 80	TXN 133 33 3 Buttons 1 RTD external LCD Page 81	<b>NEW</b> TXN 133 37 3 Buttons, 1× temperature 1× humidity backlit LCD Page	TXN 131 57 1 rotational button 1 RTD external LCD Page 82

CIB modules for interior

on valve







C-AQ-0001R	C-AQ-0002R	C-AQ-0003R	C-AQ-0004R	C-HC-0201F-E
				
TXN 133 12 Concentration CO <sub>2</sub> Page 83	TXN 133 13 Concentration VOC Page 83	TXN 133 14 Smoke concentration Page 83	TXN 133 15 Relative humidity Page 83	TXN 133 48 2 AI/DI Valve drive Page 85

Modules on CIB bus with IP65 protection

C-IT-0200I	C-AM-0600I	C-IT-0100H-P	C-IT-0100H-P	C-IT-0100H-P	C-IT-0100H-A	C-RI-0401I
						
TXN 133 09 2 AI Page 67	TXN 133 50 6 AI/DI Page 68	TXN 133 16.11 1 AI Page 69	TXN 133 16.12 1 AI Page 69	TXN 133 16.01 1 AI Page 69	TXN 133 17.01 1 AI Page 69	<b>NEW</b> TXN 133 47.92 1 temperature 1 lighting Page 70





Modules for wireless network RFox

Portable mobiles







RF-1131	R-RT-2305W	AN-06	AN-RFox/GSM	R-KF-0400T	R-KF-0500T
					
TXN 111 31 Master for 64 RFox modules Page 88	TXN 132 34 Router into socket	AN-06 Antenna RFox 868 MHz	31-01-01.001 Antenna RFox/GSM	TXN 132 25 4 buttons Page 92	TXN 132 08 5 buttons Page 92







Interior modules for wireless network RFox

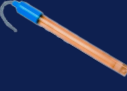
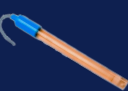



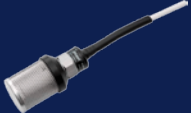

R-WS-0200R	R-WS-0400R	R-IT-0100R	R-RC-0001R	R-AQ-0001R	R-AQ-0002R	R-AQ-0003R	R-AQ-0004R
							
TXN 132 30 2 buttons Page 89	TXN 132 31 4 buttons Page 89	TXN 132 32 1 RTD Page 89	TXN 132 09 1 RTD, Control button Page 90	TXN 132 12 Concentration CO <sub>2</sub> Page 97	TXN 132 13 Concentration VOC Page 97	TXN 132 13 Smoke concentration Page 97	TXN 132 15 Relative humidity Page 97







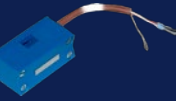

RFox modules on DIN rail		for valve		into installation box
R-HM-1113M	R-HM-1121M	R-HC-0101F	R-IB-0400B	R-OR-0001B
				
TXN 132 10 3 AI, 8 DI 11 RO, 2 AO Page 93	TXN 132 11 3 AI, 8 DI 19 RO, 2 AO Page 93	TXN 132 28 1 AI Valve drive Page 82	TXN 132 04 4 DI Page 95	TXN 132 01 1 RO Page 96

## Accessories (complementary products)

Electricity meters, flow meters, water quality sensors							
ED11.M	ED 110.D0	ED 310.DR	Opto probe	Water meter 3/4"	AV23	pH	Redox
							
ED11.M 1f 230 V/25 A S0 pulse output	ED 110.D0. 14E302-00 1f 230 V/32 A S0	ED 310.DR. 14E304-00 3f 230 V/64 A S0, RS-485	TXN 149 01 EN 62056-21 RS-232	3/4" BONEGA-T-E/20 2.5 m <sup>3</sup> /hour Pulse output	223.7704.000 2.40m <sup>3</sup> /min 1 flow, 1 temperature	SPH-1-S6 pH	SRX-1-PT-S6 Redox

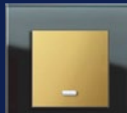

Meteostations, sensors of condensation, humidity, inundation and level						
Meteostation	Condensation	Humidity at flat space	Humidity at gutter	Inundation	Water level	Level meter
						
GIOM 3000 Direction and speed of wind, air pressure, humidity, temperature Ethernet	SHS A1 condensation <150 kΩ	ESF 524 001 Humidity at flat space RTD	ESD 524 003 Humidity at gutter	DS conductivity contact	CLS-23S-11 capacitive 1 OC	HLM-25S-I-1000 hydrostatic 4 – 20 mA

Temperature RTD sensors							
NTC Cable	Pt1000 Cable	Ni1000 Cable	NTC S-TS-01R	Pt1000 Outside	Pt1000 Strap	Pt1000 for HVAC	Pt1000 for sump
							
SK8NTC 12k-2PS	SK2PA-2SS	SK8S-2PS	TXN 134 01.01	P11PA	P15PA	P11PA	P13PA

Temperature sensors for interior							
Legrand	Eaton	Unica	Bticino	Logus	Decente	Gira	Merten
							
C-IT-0200R-Zak TXN 133 20	C-IT-0200R-Zak TXN 133 20	C-IT-0200R-Zak TXN 133 20	C-IT-0200R-Zak TXN 133 20	C-IT-0200R-Zak TXN 133 20	C-IT-0200R-Zak TXN 133 20	C-IT-0200R-Zak TXN 133 20	C-IT-0200R-Zak TXN 133 20

Accessories – heating



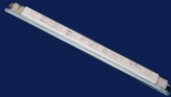
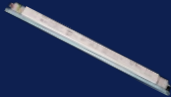



Accessories - Lighting

Valve drive 230 V	Valve drive 24 V	Valve drive 0–10 V		Ballast DALI	Ballast 1–10 V
					
Alpha AA 2004/230	Alpha AA 4004/24 V	Alpha AA 5004 0–10 V		EL 1×XX si Fluorescent tubes T8, T5	EL 1×XX sc Fluorescent tubes T8, T5







Accessories – access system

RFID card reader	RFID card reader	Card reader with keyboards		
				
AXR-100 Wiegand Page 63	SSA-R1100 Wiegand Page 63	SSA-R2000 V Wiegand Page 63		







Accessories – security systems, electronic guard system detectors

Motion detector	Motion and glass break detector	Glass break detector	Door contact	Gate contact	Indoor sirene
					
JS-20 LARGO Page 106	JS-25 COMBO Page 106	GBS-210 VIVO Page 106	SA-200A Page 106	SA-204 Page 106	SA-913 Page 106

Accessories – security systems, electronic guard system detectors

Prestige QD	Prestige PW	Prestige DT	Prestige Orbit DT	Prestige External TD	Trired	Impaq Glass Break
						
031 30300 Quad PIR sensor 42 detection zones 2 contacts Page 64	031 30700 24 detection zones 2 contacts Page 64	034 30100 Dual MW+PIR 42 detection zones 2 contacts Page 64	031 32101 Outdoor dual PIR+ MW 2 contacts Page 64	031 32000 Outdoor dual PIR 2 contacts Page 64	031 74600 Outdoor triple PIR motion detector 2 contacts	032 00700 Acoustic glass break detection 2 contacts

Accessories – security systems, electronic fire system detectors

EXODUS OH/4W	EXODUS RR/4W	EXODUS FT64/4W	EXODUS FT90/4W	GS-133	SD-282ST
					
231 05100 Dual, smoke and temperature 1 contact Page 64	231 05200 Temperature increase 1 contact Page 64	231 05300 Max. temperature >64°C 1 contact Page 64	231 05400 Max. temperature >90°C 1 contact Page 64	GS-133 Flammable gases 1 contact Page 106	SD-282ST Smoke and high temperature 1 contact



**Foxtrot**  
PLC Basic modules

**Foxtrot**  
PLC Expansion modules

**Foxtrot**  
Communication modules

**Displays**  
Operator panels

**CFox**  
Sensors and actuators for CIB  
Common Installation Bus

**RFox**  
Wireless sensors and actuators

**Power supplies**

**Accessories**  
Sensors, detectors etc.



# PLC Foxtrot

## Central module communication lines schema

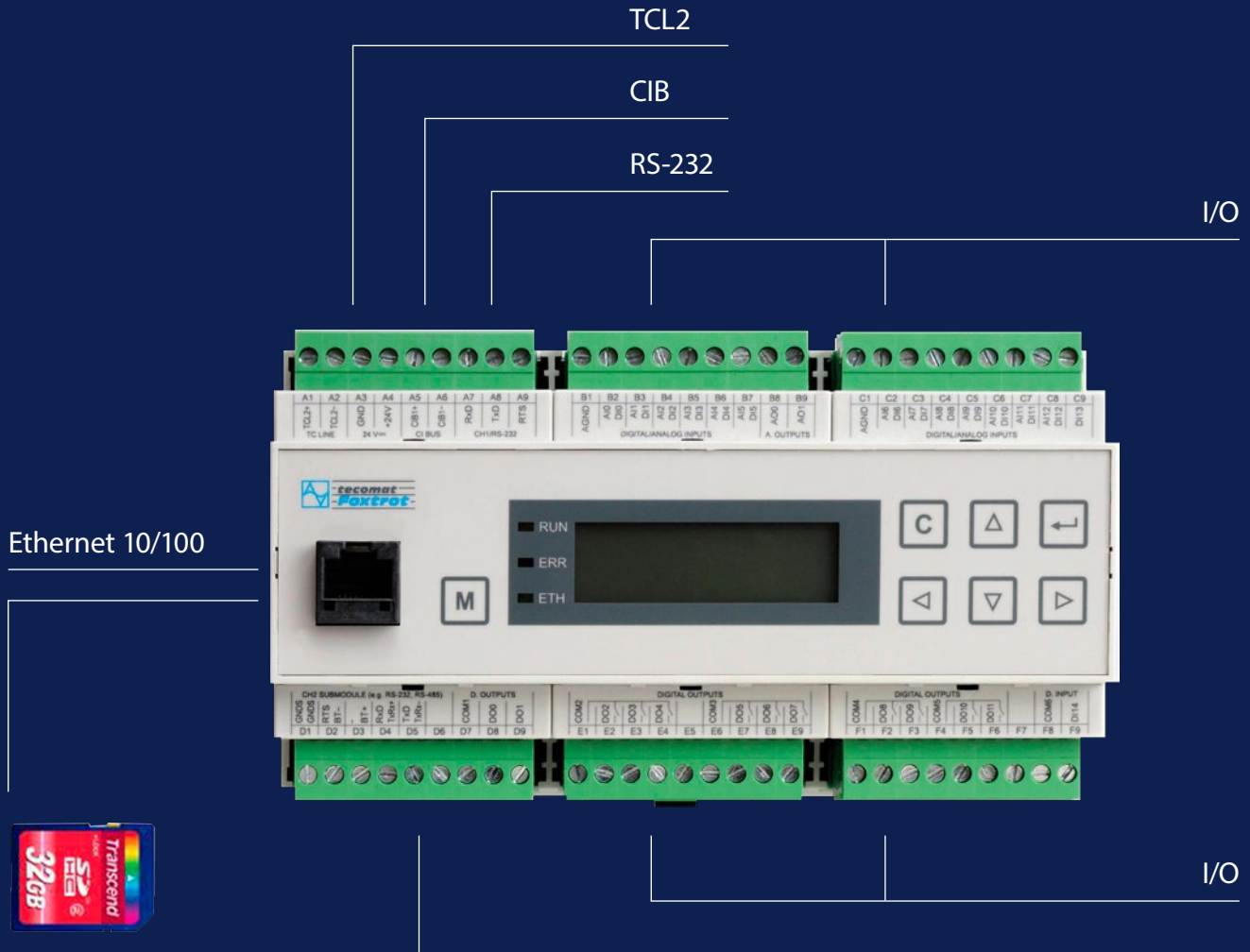

Mass storage  
SD/SDHC/MMC



Optional interface

- RS-232
- RS-422
- RS-485
- RS-485/Profibus
- 2 × DMX512
- M-bus
- CAN
- Parallel I/O

Modules connected to the system are mentioned in other parts of the catalog.

# PLC Foenix

## Basic modules

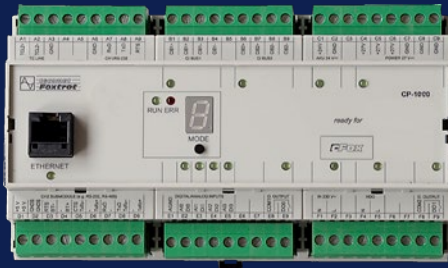

CP-1000



CP-1003

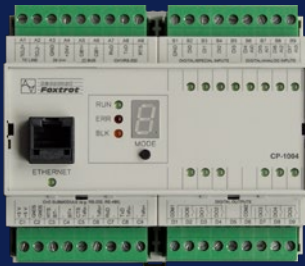

CP-1004



CP-1014



CP-1005



CP-1015



CP-1006



CP-1016

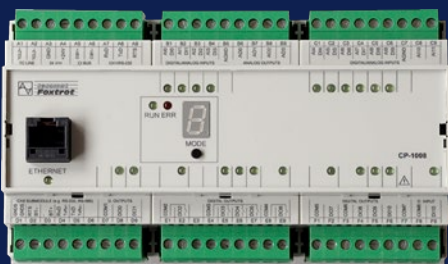

CP-1008

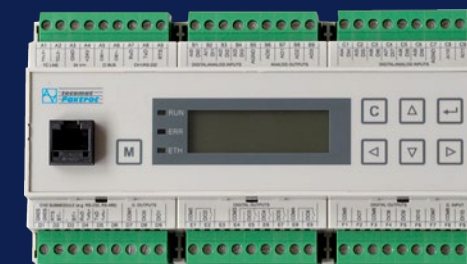

CP-1018



## Central module for building automation projects with CFox and RFox modules

Type	DI	RO	AI	AO	Comm
<b>CP-1000</b>	2×DI/230 VAC	2×RO	4×AI/DI		2×CIB, 1×TCL2 1×Ethernet 10/100, 1×RS-232, 1×optional

### Basic features

- Outstanding integration of control system with latest IT technologies and telecommunication technologies.
- Central module with 4 universal inputs, 2 inputs 230 V AC and 2 relays outputs.
- Universal inputs may be configured as analog inputs for connecting temperature sensors Pt1000, Ni1000 or NTC thermistor 12 kΩ or as potential-free digital inputs.
- Digital inputs 230 V AC for connecting MRC (Mass Remote Control) signal and 230 V AC network monitoring.
- Standard relay outputs 250 V AC/3 A.
- Extension of I/O up to 10 peripheral modules on serial bus TCL2 (345 kbit/s).
- Expandable memory with SD/SDHC/MMC cards, built-in file system FAT32.
- Built-in clocks and calendar.
- Central module contains 2 CIB bus masters. It enables connect up to 64 inputs and outputs modules CFox in any combination and in any mechanical design.
- On terminals CIB+ and CIB- there is a powered bus.
- Number of CIB branches is expandable up to 10 via up to 4 optional masters CF-1141 connected on TCL2 bus, enabling up to 320 modules CFox.
- Optional connection up to 4 RFox masters RF-1131 via TCL2 on radio channel 868 MHz.
- External masters of CIB bus CF-1141 and wireless system RFox RF-1131 may be combined up to total number 4 masters on 1 central module.
- There is built-in serial channel RS-232 for connection GSM modems for direct communication with mobile phones, sending SMS messages etc or for general purpose.
- Next channel CH2 enables connection of optional communication interface submodule or inputs/outputs. Other 6 channels can be added using communication channels SC-1101 or SC-1102.
- Programming and communications (LAN, WiFi, WAN, internet) via ethernet (100 Mbit/s), adjustable fixed IP address or assigned by DHCP.
- Support of standard protocols Modbus RTU/TCP (master and slave) and BACnet (slave).
- Built-in web server, free user programmable web pages stored on memory card (XML technology is used).
- Enables to create web page of any connected controlled object.
- Possibility to use as programmable converter of communication protocols.
- Possibility to use as independent programmable datalogger for any measured or internal values with time stamp.
- Compact dimensions and form factor fit for standard electro-installation switchboards assembled on DIN rail.
- Central module is powered from 24 V DC power supply. If 27.2 V power supply is used, it is possible to connect Pb accumulators and keep the system in operation during power fail for time depending on capacity of used accumulators.
- For automation control in buildings and residential houses for common and complex tasks with needs to integrate with other systems mostly via communication interfaces.
- Central module may be free programmed in Mosaic software or parametrized in parametrization software FoxTool.



CP-1000

### Related products



Submodules with inputs/outputs



Communication submodules MR-01xx

### Connection example

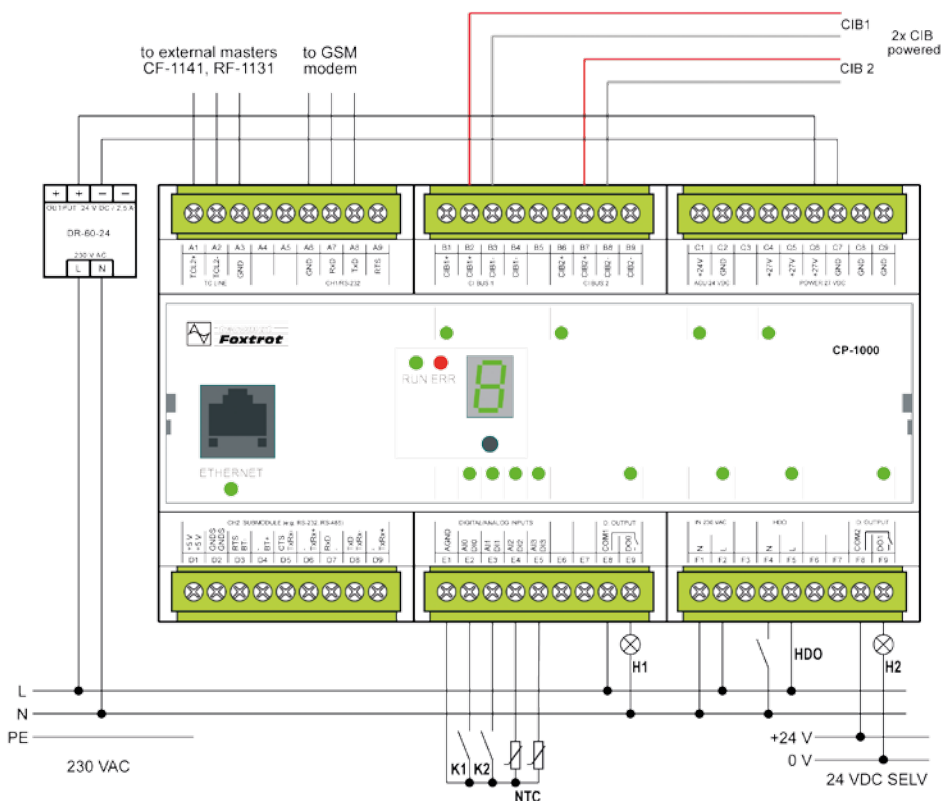



CP-1000

Communication	
Ethernet; supported protocols	1 × 100/10 Mbit/s; TCP/IP, UDP, HTTP; SMTP; MODBUS/TCP, BACnet, IEC 60870-5-104
Serial ports	1 × RS232; 1 × optional slot, optional Interface (see submodules MR-0xxx)
System I/O bus	1 × TCL2 (RS485, 345 kbit/s)
Communication over expansion module on TCL2 bus	CIB, RFox, MPbus, Opentherm
Installation bus	2 × CIB (19.2 kbit/s) (Common installation bus)

Features of CPU	
CPU	32 bit RISC processor
PLC Instruction cycle	0.2 ms/1k instructions
Real Time Clock (RTC)	Yes
Backup period of RAM and RTC	500 h without battery 20 000 h with battery
User program memory	192+64 kB
Program memory backup	Yes
Internal data memory (DataBox)	0.5 MB
Archive memory for the project resource files	2 MB
Memory card slot	Yes, MMC/SD, SDHC
Memory for variables	64 kB/32 kB remanent

Universal inputs (DI0/AI0-DI3/AI3)	
Number inputs	4
Configurable inputs	Resistance measurement. Binary input (See separate table).
Common wire	minus (AGND)
Galvanic isolation	No

Funkcion Analog inputs (AI0–AI3)	
Resolution	12 bit
Conversion time	type 50 µs/1 input
Measurement repeating	type 650 µs
Protection type	integrated, overvoltage

Measurement ranges	
Resistance Temperature Detectors (RTD)	
Input impedance	> 4 kΩ
Input range	Pt1000 1.385 (–90 up to +270°C) Pt1000 1.391 (–90 up to +2700°C) Ni1000 1.617 (–60 up to +155°C) Ni1000 1.500 (–60 up to +155°C) NTC 12k (–40 up to +125°C) KTY81-121 (–55 up to +125°C) resistance transmitter 0 up to 2000 Ω resistance transmitter 0 up to 200 kΩ
Max. error at 25 °C	±0.5% of full range ±10% for range 0 up to 200 kΩ
Allowed overload	–20 up to +35 V (between AI and AGND)
Sensor disconnection detection	Yes, in status word

Operating conditions	
Operating temperature	–20 .. +55 °C
Storage temperature	–25 .. +70 °C
Electric strength	according EN 60950
IP Degree of protection IEC 529	IP 20
Overvoltage category	II
Pollution degree IEC EN 60664–1:2004	1
Working position	vertical
Installation	on DIN rail
Connections	Screw connectors
Conductors cross-section	max. 2.5 mm <sup>2</sup>

Order number	
TXN 110 00	CP-1000, CPU, ETH100/10, 2×CIB, 1×RS232, 1×SCH, 4×AI/DI, 2×DI 230 VAC, 2×RO, prg. Mosaic/FoxTool

Function Digital inputs (DI0-DI3)	
Input voltage for log. 0 (U <sub>i0</sub> )	min. 2.3 V, max. 12 V
Input voltage for log. 1 (U <sub>i1</sub> )	min. 0 V, max. 1 V
Input current for log. 1 (I <sub>h1</sub> )	typ. – 1.7 mA
Delay 0 → 1/1 → 0	1 ms/1 ms

Digital inputs 230 V AC (HDO, IN 230 VAC)	
Galvanic isolation	Yes, 4 kV
Input voltage for log.0 (U <sub>i0</sub> ):	max. 120 V AC
Input voltage for log.1 (U <sub>i1</sub> ):	min. 200 V AC
Input current for log.1 (I <sub>h1</sub> ):	typ. 5 mA
Delay 0 → 1/1 → 0:	10 ms/10 ms

Relay outputs (DO0–DO1)	
No. of outputs × groups	2 (1+1)
Galvanic isolation	Yes (outputs each other)
Type of contact/type of output	NO relay, unprotected output
Switched voltage	min. 5 V; max. 250 V
Switched current	min. 10 mA; max. 3 A
Short-term output overload	max. 4 A
Time of close/open the contact	typ. 10 ms/4 ms
Threshold limits of switched loads	
for resistive load	max. 3 A at 30 V DC or 230 V AC
for inductive load DC13	max. 1 A at 30 V DC
for inductive load AC15	max. 3 A at 230 V AC
Switching frequency without load	max. 300 switchings/min.
Switching frequency with rated load	max. 20 switchings/min.
Mechanical/Electrical lifetime at max. load	min. 5 mil./100 000 cycles
Short-circuit protection	No
Spike suppressor of inductive load	External. (RC unit, varistor, diode)
Insulation voltage	3750 V AC (more details see documentation of TXV 004 11)

Dimensions and weight	
Dimensions	158×92×63 mm
Weight	250 g

Power supply	
Power supply voltage (SELV)	+24 V DC
Allowed range	–15% + 25% (20.4 – 30 V DC)
Max. power consumption	75 W
Galvanic isolation	No, only relay outputs, HDO, IN 230 VAC and CH2
Memory backup	Built-in Li-Ion accumulator (500 hours) Holder for lithium battery CR2032 (20 000 hours)

Type	DI	RO	AI	AO	Comm
<b>CP-1003</b>	8×DI/HSC	7×RO/3 A 1×RO/10 A 4×DO/PWM	8×DI/AI	4×AO	Ethernet 10/100, 2×TCL2, 1×RS485

## Basic features

- Programmable controller (PLC) according to IEC 61131 standard with 32 I/O on basic module and with increased number of 20 extension modules up to 272 I/O in total.
- Built-in ethernet port 100 MBit and serial port RS-485 with option to expand with up to 3 other serial ports directly in basic module.
- Powerful central module with practical configuration of 32 integrated inputs and outputs.
- 2×4 digital inputs with selectable voltage level and with alternative function of fast counters up to 100 kHz.
- 8 universal inputs selectable as analog or digital ones. Optional voltage, current and resistance range.
- 4 analog outputs with voltage range ±10 V and resolution 12 bit.
- 4 extra fast semiconductor digital outputs with optional function frequency output, pulse wide modulation (PWM), direct control of DC motors or direct control of stepper motors up to frequency 100 kHz.
- 8 relay outputs. 1 of them has possibility to switch 10 A/230 V AC. 7 outputs switch up to 3 A.
- Expandable memory with SD/SDHC/MMC cards, built-in file system FAT32.

- Built-in clocks and calendar.
- Extension of I/O number with next up to 20 extension modules on 2 serial buses TCL2 (345 kbit/s).
- Option to create network of more PLC Tecomat in ethernet network on RS-485 bus.
- Free programmable according to IEC 61131-3 standard.
- On-line programming during operation.
- Programming and communication via ethernet (100 Mbit/s), adjustable fixed IP address or DHCP.
- Up to 4 serial channels, one RS-485 is in basic configuration, others with optional interface from range MR 01xx (up to 345 kbit/s), adjustable UART. Other 6 optional channels can be added using communication modules SC-1101 or SC-1102.
- Built-in PROFIBUS DP Master up to 180 kbit/s.
- Built-in WEB server, free web page designing, storing web pages at memory card (XML technology).
- Enables to create web page of any connected controlled object.
- May be used also as programmable converter of communication technologies.
- May be used as independent programmable datalogger for any measured or internal values with time sign.
- Compact dimensions fit for standard electroinstallation switch boxes, assembly on DIN rail.

## Connection example



## CPU characteristics

<b>CPU</b>	32 bit RISC processor
<b>PLC cycle time</b>	0.2ms/1k instructions
<b>Real Time Clock RTC</b>	Yes
<b>Back up RAM and RTC</b>	500 h/20 000 h without/with battery
<b>User program and table memory</b>	384 + 64 kB
<b>Back up memory program</b>	Yes
<b>Internal memory – DataBox</b>	0.5 MB
<b>Memory for program archiving</b>	2 MB
<b>Slot for memory cards</b>	Yes, SDHC/SD/MMC
<b>Memory for variables</b>	192 kB/48 kB remanent
<b>No. of IEC timers/counters</b>	4096/8192

## Binary/counter inputs DI8-DI11, DI12-DI15

<b>Binary/Counter inputs</b>	4×2
<b>Optional input functions</b>	4×counter or 2×IRC (encoder) up to 100 kHz
<b>Common wire</b>	minus (GNDA, GNDB)
<b>Galvanic isolation</b>	Yes, by groups
<b>Threshold level at input</b>	Yes, 5–24. Adjustable by ref. voltage at input VDIA, resp. VDIB
<b>Input voltage for. 0</b>	Max. 0,25 U <sub>DN</sub>
<b>Input voltage for. 1</b>	Min. 0,6 U <sub>DI</sub>
<b>Input resistance for. 1</b>	Typ. 4,5 kΩ
<b>Delay 0→1/1→0</b>	2μs/2μs

## Communication

<b>Ethernet</b>	1×10/100Base T
<b>Supported protocols</b>	TCP/IP, UDP, http, SMTP, Modbus TCP, BACnet
<b>Serial channels</b>	1×RS-485 (CH1) a 1×free slot CH2 for submodule (see MR-01xx)
<b>System I/O bus</b>	2×TCL2 (RS-485, 345 kbit/s)
<b>Communication via expansion module on TCL2 bus</b>	CIB, RFox, MP-BUS, OpenTherm
<b>Bus for electroinstallation</b>	Only with external master CF-1141

## Analog/digital inputs DI0/AI0-DI7/AI7

<b>No. of inputs×groups</b>	8×1
<b>Optional input function</b>	• Digital input • Voltage range: 0–2 V, 0–10 V • Current range: 0–20 mA, 4–20 mA • Resistance range: 0–2 kΩ, 0–200 kΩ NTC, 12k, KTY81–121, Ni1000, Pt1000
<b>Common wire</b>	Minus (AGND)
<b>Galvanic isolation</b>	Yes, from the rest of module, AI is connected only with AO
<b>Resolution</b>	12 bit
<b>Time of transaction</b>	80 μs/1 input
<b>Measurement repeating</b>	480 μs
<b>Protection type</b>	Integrated, overvoltage



CP-1003

## Related products



Submodules with inputs/outputs



Communication submodules MR-01xx

### Digital transistor outputs DO8-DO11

No. of inputs	4
Galvanic isolation	Yes, transistor output, isolated from the rest of module
Output type	Push-Pull – couple transistors switching into VCC and GND. May be grouped by two and create 2x full bridge.
Optional output functions	Frequency output, PWM output, DC motor control. With connecting motor into bridge between 2 outputs the speed and direction can be controlled.
Common wire	minus (GND)
Switched voltage	10 – 32 V DC
Switched current permanent/pulse	Max. 2,7 A/4 A
Residual current at switching off	12 mA
Time of switch on/off	1.6µs/0.6µs
Switching speed	Max. 100 kHz

### Analog outputs AO0-AO3

No. of outputs	4
Galvanic isolation	Yes, AO is connected only with AI
Common wire	Minus AGND
Resolution	12 bit
Output range/current	±10 V/max. 10 mA
Time of conversion	10µs



CP-1003

### Relay outputs DO0-DO7

Number of outputs	7x3 A (DO0-DO6), 1x10 A (DO7) divided in 4 groups
Galvanic isolation	Yes (also among groups)
Type of contact/output	NO relay, unprotected output
Switched voltage	Min. 5 V, max. 250 V AC
Switched current	Min. 10 mA; max. 3 A (DO7-10 A)
Short term output overload	Max. 4 A (DO7-10 A)
Common wire current	Max. 15 A
Time to close/open the contact	Typ. 10 ms/4 ms
Switching frequency without the load	Max. 300 switchings/min, 60 switchings/min (DO7)
Switching frequency with rated load	Max. 20 switchings/min, 6 switchings/min (DO7)
Mechanical/Electrical lifetime at max. load	Min. 5 mil/100 000 cycles
Short-circuit protection	No
Spike suppressor of inductive load	External. (RC unit, varistor, diode)
Isolation voltage	3750 V AC

### Operating conditions CP-1003

Operating temperature	-20 .. +55 °C
Storing temperature	-25 .. +70 °C
Electric strength	according EN 60950
Degree of protection IP (IEC 529)	IP20
Overvoltage category	II
Degree of pollution according ČSN EN60664-1:2004	1
Operation position	Vertical
Installation	into switching board on DIN rail
Connection	screw terminals
Wire diameter	DI, AI, AO, DO0, CH2 – 1.5 mm <sup>2</sup> , Others max. 2.5 mm <sup>2</sup>

### Dimensions and weight CP-1003

Dimensions	158x92x63 mm (9M)
Weight	250 g

### Power supply CP-1003

Nominal voltage – (SELV)	+24 V DC
Tolerance	-15% ..+25%; 20.4..30 V DC,
Max. input power	10 W
Internal protection	Yes
Galvanic isolation	Inputs and outputs yes, communication no
Back up memory	Built-in Li-Ion accumulator (500 hours). Holder for lithium battery.

### Order number

TXN 110 03	CP-1003; CPU, ETH100/10, 1xRS485, 1xSCH, 8xAI/DI, 8xDI/HSC, 4xAO, 8xRO, 4xDO, 2xTCL2
------------	--



## Basic module with 14 I/O (max. 21 I/O) with counter inputs

Type	DI	RO	AI	AO	Comm
<b>CP-1004</b> <b>CP-1014</b>	8×DI of which 4×DI/AI, and 4×DI/HSC	6×RO			Ethernet 10/100, RS-232, 1×optional interface, 1×TCL2, 1×CIB, RFox optional

### Basic features

- Programmable controller (PLC) according to IEC EN 61131 standard.
- Outstanding integration of control system with latest IT and telecommunication technologies.
- Powerful central module with integrated mostly binary inputs and relay outputs (I/O).
- Type CP-1014 with built-in display 4×20 characters and 6 user keys, other features the same with CP-1004. Available code pages: CP1250 (Central European), CP1251 (Cyrillic), CP1252 (Western European), CP1253 (Greek), CP1255 (Hebrew).
- 4 inputs may be configured as High speed counters (HSC) and 4 as voltage analog inputs.
- Optional slot can be inserted by additional 7×DI or 4×DI/3×DO on submodules PX-781x.
- Memory expandable by SD/SDHC/MMC cards, built-in file system compatible with FAT32.
- Built-in clocks and calendar.
- No. of I/O is expandable up to 134 I/O, resp. up to 10 modules on high speed internal serial bus TCL2 (345 kbps).
- Other I/O can be expanded also by 2 wire installation bus CIB (19.2 kbps).
- More PLC Tecomat can be networked by Ethernet LAN or by RS-485 bus.
- Free programmable PLC according to IEC EN 61131-3.
- On-line programming during operation.
- Programming and data communication (in LAN, WiFi, WAN, Internet) is available on Ethernet port (100 Mbps) with fixed IP address or DHCP.
- Up to 10 serial ports: one RS-232, other 3 with optional interface (up to 345 kbps), configurable UART. Other 6 with additional communication modules SC-1101 and SC-1102.
- Built-in PROFIBUS DP Master, Modbus RTU/TCP slave, IEC 60870-5-104 as payed application profile.
- Built-in BACnet slave on Ethernet port.
- Built-in web server, free creation of user internal web site stored on memory card (XML technology).
- Enables to create web page of any connected controlled object.
- May be used as programmable converter of communication protocols.
- May be used as independent programmable datalogger for any measured or internal values.
- Compact form-factor for DIN rail mounting (6 modules width) for standard circuit breaker cabinets.
- Removable connectors instead of fixed terminals.

### Connection example

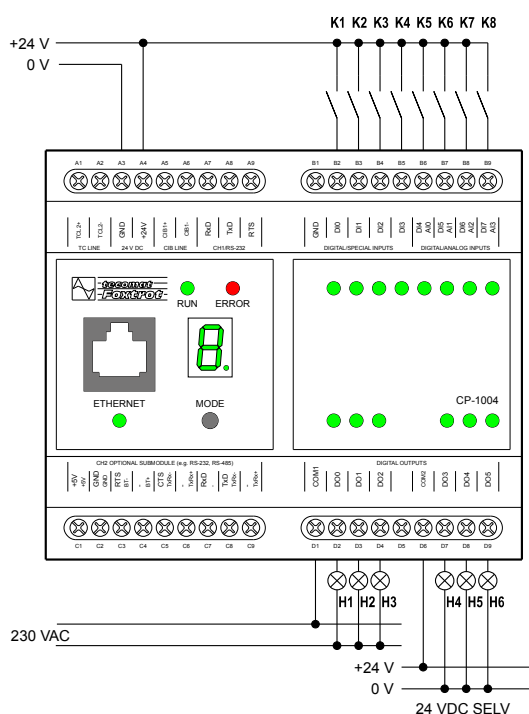

### Features of CPU

CPU	32 bit RISC processor
PLC Instruction cycle	0.2 ms/1 k instructions
Real Time Clock (RTC)	Yes
Backup period of RAM and RTC	500h without battery, 20 000h with battery
User program memory	192+64 kB
Program memory backup	Yes
Internal data memory (DataBox)	0.5 MB
Archive memory for the project resource files	2 MB
Memory card slot	Yes, MMC/SD, SDHC
Memory for variables	64 kB/32 kB Remanent
No. of IEC timers/counters	4096/8192

### Digital inputs (DI0–DI7)

No. of inputs × groups	8 × 1
Option: High speed counter	4 (DI0–DI3)
Option: Analog inputs	4 (DI4–DI7)
Common wire	minus (GND)
Galvanic isolation	No
Input voltage for log. 0 (U <sub>0</sub> )	0 V DC; (–5 ÷ +5 V DC)
Input voltage for log. 1 (U <sub>1</sub> )	+24 V DC; (+15 ÷ +30 V DC)
Input current for log. 1 (I <sub>1</sub> )	typ. 5 mA
Delay 0 → 1/1 → 0:	5 μs/5 μs (DI0–DI3) 5 ms/5 ms (DI4–DI7)

### High speed counters (DI0–DI3)

No. of counting inputs	4
Input Frequency/	5 kHz/20 000 edges/sec
Pulse width	min. 50 μs
Delay 0 → 1/1 → 0	5 μs
Range	max. 32 bit; 0 ÷ 4 294 967 295
Modes	One, two way counter, encoder, pulse and period measuring

### Analog inputs (DI4–DI7)

Number of inputs	4
Common wire	minus (GND)
Galvanic isolation	No
Resolution/Range	10 bit/0 – 10 V
Conversion time	350 μs/1 input
Max. error at 25 °C	± 3 % of full range

### Communication

Ethernet; supported protocols	1 × 10/100 BaseT; TCP/IP, UDP, HTTP, SMTP; MODBUS TCP, BACnet, IEC 60870-5-104
Serial ports	1 × RS-232; 1 × free slot for optional interface (see submodules MR-0xxx)
System I/O bus	1 × TCL2 (RS-485, 345 kbit/s)
Communication over expansion module na TCL2	CIB, RFox, MP-Bus, OpenTherm
Installation bus	1 × CIB (Common installation bus 19.2 kbit/s)



CP-1004



CP-1014

### Related products



Submodules with inputs/outputs



Communication submodules MR-01xx

Relay outputs (DO0–DO5)	
No. of outputs × groups	3 × 2
Galvanic isolation	Yes (also among groups)
Type of contact/type of output	Electromechanical relay, non-protected output
Switched voltage	min. 5 V; max. 250 V AC
Switched current	min. 100 mA; max. 3 A
Short-term output overload	max. 4 A
Current through joint terminal	max. 10 A
Time of close/open the contact	typ. 10 ms/4 ms
Threshold limits of switched loads	
for resistive load	max. 3 A at 30 V DC or 230 V AC
for inductive load DC13	max. 3 A at 30 V DC
for inductive load AC15	max. 3 A at 230 V AC
Switching frequency without load	max. 300 switches/minute
Switching frequency with rated load	max. 20 switches/minute
Mechanical/Electrical lifetime at max. load	min. 5 mil/100 000 cycles
Short-circuit protection	None
Spike suppressor of inductive load	External RC, varistor or diode snubber
Insulation voltage	3750 V AC

Operating conditions	
Operating temperature	–20 ÷ +55 °C
Storage temperature	–25 ÷ +70 °C
Electric strength	According EN 60950
IP Degree of protection CSN EN 60529	IP 20B
Overvoltage category	II
Degree of pollution IEC EN 60664-1:2004	1
Working position	Vertical
Installation	On DIN rail
Connections	Screw terminals
Conductors cross-section	max. 2.5 mm <sup>2</sup>

Dimensions and weight	
Dimensions	105 × 92 × 63 mm
Weight	250 g

Power supply	
Power supply voltage (SELV)	+24 V DC
Allowed range	–15% +25% (20.4 ÷ 30 V DC)
Max. power consumption	10 W
Galvanic isolation	No
Memory backup	Built in Li-Ion accumulator (500 hours); Holder for CR2032 lithium battery (for 20 000 hours)



CP-1004



CP-1014

Order number	
TXN 110 04	CP-1004, CPU, ETH100/10, 1 × RS-232, 1 × SCH, 4 × DI/AI, 4 × DI/HSC, 6 × RO 230 V/3 A, 1 × CIB, SW Mosaic
TXN 110 14	CP-1014, CPU+LCD 4 × 20, ETH100/10, 1 × RS-232, 1 × SCH, 4 × DI/AI, 4 × DI/HSC, 6 × RO 230 V/3 A, 1 × CIB, SW Mosaic

## Basic module with 14 I/O (max. 21 I/O) for use in measurement and regulation

Type	DI	RO	AI	AO	Comm
<b>CP-1005</b>		6 × RO	6 × AI/DI	2 × AO	Ethernet 10/100, RS-232, 1 × optional interface, 1 × TCL2, 1 × CIB
<b>CP-1015</b>					

### Basic features

- Programmable controller (PLC) according to IEC EN 61131 standard.
- Outstanding integration of control system with latest IT and telecommunication technologies.
- Powerful central module with integrated mostly analog inputs and analog outputs plus relay outputs (I/O).
- Type CP-1015 is expanded with built-in display 4 × 20 characters and 6 keys. Available code pages: ASCII, CP 1250 (Central European), CP 1251 (Cyrillic), CP 1252 (Western European), CP 1253 (Greek), CP1255 (Hebrew). Other features are the same with CP-1005.
- Optional slot can be inserted by additional 7 × DI or 4 × DI/3 × DO on submodules PX-781x.
- Each of 6 universal inputs may be alternatively used as analog or digital input.
- The type of analog input (U, I, RTD) and range of measurement are set in user configuration.
- Memory expandable by SD/SDHC/MMC cards, built-in file system compatible with FAT32.
- Built-in clocks and calendar.
- No. of I/O is expandable up to 134 I/O, resp. up to 10 modules on high speed internal serial bus TCL2 (345 kbps).
- Other I/O can be expanded also by 2 wire installation bus CIB (19.2 kbps).
- More PLC Tecomat can be networked by Ethernet LAN or by RS-485 bus.
- Free programmable PLC according IEC EN 61131-3.
- On-line programming during operation.
- Programming and data communication (in LAN, WiFi, WAN, Internet) is available on Ethernet port (100 Mbps) with fixed IP address or DHCP.
- Up to 4 serial ports, one RS-232, the others with optional interface from line MR 01xx (up to 345 kbps), configurable UART. Other 6 with additional communication modules SC-1101 and SC-1102.
- Built-in PROFIBUS DP Master, Modbus RTU/TCP slave, BACnet slave on Ethernet port, IEC 60870-5-104 as payed application profile.
- Built-in web server, free creation of user internal web site stored on memory card (XML technology).
- Enables to create web page of any connected controlled object.
- May be used as programmable converter of communication protocols.
- May be used as independent programmable datalogger for any measured or internal values.
- Compact form-factor for DIN rail mounting (6 modules width) for standard circuit breaker cabinets.
- Removable connectors instead of fixed terminals.



CP-1005



CP-1015

### Related products



Submodules with inputs/outputs PX-7811, PX-7812



Communication submodules MR-01xx

### Connection example

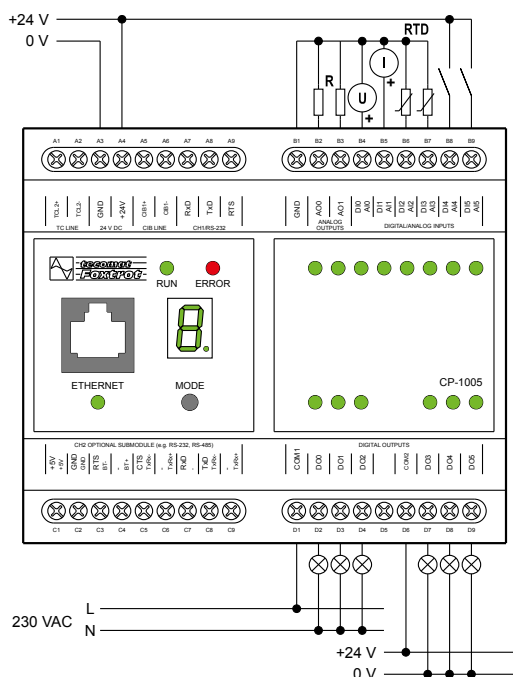

Analog inputs (AI0-AI5)	
No. of inputs × groups	6 × 1
Configurable inputs	Voltage/Current/RTD measurement Binary input See other tables
Common wire	minus (GND)
Galvanic isolation	No
Resolution	12 bit
Conversion time	80 μs per input
Sample repetition period	480 μs
Protection type	Overvoltage, integrated

Digital inputs (DI0-DI5) Alternative function	
No. of inputs × groups	6 × 1
Option: Analog inputs	See Analog inputs
Common wire	minus (GND)
Galvanic isolation	No
Input voltage for log.0 (U <sub>L</sub> )	0 V DC; (-5 ÷ +5 V DC)
Input voltage for log.1 (U <sub>H</sub> )	+24 V DC; (+15 ÷ +30 V DC)
Input current for log.1 (I <sub>H</sub> )	typ. 5 mA
Delay 0 → 1/1 → 0:	1ms/1ms

### Features of CPU

CPU	32 bit RISC processor
PLC Instruction cycle	0.2 ms/1k instructions
Real Time Clock (RTC)	Yes
Backup period of RAM and RTC	500 hours without battery 20 000 hours with battery
User program memory	192+64 kB
Program memory backup	Yes
Internal data memory (DataBox)	0.5 MB
Archive memory for the project resource files	2 MB
Memory card slot	Yes, MMC/SD, SDHC
Memory for variables	64 kB/32 kB remanent
No. of IEC timers/counters	4096/8192

### Communication

Ethernet; supported protocols	1 × 10/100 BaseT; TCP/IP, UDP, HTTP, SMTP; MODBUS/TCP, BACnet, IEC 60870-5-104
Serial ports	1 × RS-232; 1 × free slot for optional interface (see submodules MR-0xxx)
System I/O bus	1 × TCL2 (RS-485, 345 kbit/s)
Communication over expansion module at TCL2	CIB, RFox, MP-Bus, OpenTherm
Installation bus	1 × CIB (Common installation bus 19.2 kbit/s)



### Analog outputs

No. of outputs × groups	2 × 1
Common wire	minus (GND)
Galvanic isolation	No
Resolution	12 bit
Conversion time	10 μs per output
Max. output current	10 mA
Output range	0 ÷ 10 V
Max. error at 25 °C	±2 % of full range
Protection type	Overvoltage, integrated
Permissible overvoltage	±20 V (between AI and GND)

### Relay outputs (DO0-DO5)

No. of outputs × groups	3 × 2 = 6
Galvanic isolation	Yes (also among groups)
Type of contact/type of output	Electromechanical relay, non-protected output
Switched voltage	min. 5 V; max. 250 V AC
Switched current	min. 10 mA; max. 3 A
Short-term output overload	max. 4 A
Current through joint terminal	max. 10 A
Time of close/open the contact	typ. 10 ms/4 ms
Threshold limits of switched loads	
for resistive load	max. 3 A at 30 V DC or at 230 V AC
for inductive load DC13	max. 3 A at 30 V DC
for inductive load AC15	max. 3 A at 230 V AC
Switching frequency without load	max. 300 switches/minute
Switching frequency with rated load	max. 20 switches/minute
Mechanical/Electrical lifetime at max. load	min. 5 mil./100 000 cycles
Short-circuit protection	None
Spike suppressor of inductive load	External RC, varistor or diode snubber
Insulation voltage	3750 V AC

### Operating conditions

Operating temperature	-20 ÷ +55 °C
Storage temperature	-25 ÷ +70 °C
Electric strength	According EN 60950
IP Degree of protection IEC 529	IP 20
Overvoltage category	II
Degree of pollution IEC EN 60664-1:2004	I
Working position	Vertical
Installation	On DIN rail
Connections	Screw terminals
Conductors cross-section	max. 2.5 mm <sup>2</sup>

### Measurement ranges

<b>Voltage</b>	
Input impedance	> 20 kΩ
Input range	0 ÷ +10 V 0 ÷ +5 V 0 ÷ +2 V 0 ÷ +1 V 0 ÷ 0.5 V
Max. error at 25 °C	±0.3 % of full range
Allowed overload	-20 ÷ 30 V (between AI and AGND)

<b>Current</b>	
Input impedance	100 Ω
Input range	0 ÷ 20 mA 4 ÷ 20 mA
Max. error at 25 °C	±0.4 % of full range
Allowed overload	±5 V/ +50 mA (between AI and GND)
Detection of open input circuit	yes, in status word

### Resistance Temperature Detectors (RTD)

Input impedance	> 50 kΩ
Input range	Pt100 1.385 (-90 ÷ +400 °C) Pt100 1.391 (-90 ÷ +400 °C) Pt1000 1.385 (-90 ÷ +400 °C) Pt1000 1.391 (-90 ÷ +400 °C) Ni1000 1.617 (-60 ÷ +200 °C) Ni1000 1.500 (-60 ÷ +200 °C) OV1000 (0 ÷ 1000 Ω)
Max. error at 25 °C	±0.5 % of full range
Allowed overload	±35 V (between AI and GND)
Sensor disconnection detection	Yes, in status word

### Dimensions and weight

Dimensions	105 × 92 × 63 mm
Weight	250 g

### Power supply

Power supply voltage (SELV)	+24 V DC
Allowed range	-15 % ÷ +25 % (20.4 ÷ 30 V DC)
Max. power consumption	10 W
Galvanic isolation	No
Memory backup	Built-in Li-Ion accumulator (500 hours) Holder for CR2032 lithium battery (20 000 hours)



CP-1005



CP-1015

### Order number

TXN 110 05	CP-1005, CPU, ETH100/10, 1 × RS-232, 1 × SCH, 6 × AI/DI, 2 × AO, 6 × RO 230 V/3 A, 1 × CIB, prg. Mosaic
TXN 110 15	CP-1015, CPU+LCD4 × 20, ETH100/10, 1 × RS-232, 1 × SCH, 6 × AI/DI, 2 × AO, 6 × RO 230 V/3 A, 1 × CIB, prg. Mosaic

## Basic modules with 29 I/O for use in HVAC

Type	DI	RO	AI	AO	Comm
<b>CP-1006</b>	1×DI/HSC 1×DI/230 VAC	2×SSR 10×RO	13×AI/DI	2×AO	Ethernet 10/100, RS-232, 1× optional interface, TCL2, CIB, optionally RFox
<b>CP-1016</b>					



CP-1006



CP-1016

## Basic features

- Programmable controller (PLC) according to IEC EN 61131 standard.
- Outstanding integration of control system with latest IT and telecommunication technologies.
- Type CP-1016 is expanded with built-in display 4×20 characters and 6 keys. Available code pages: ASCII, CP 1250 (Central European), CP 1251 (Cyrillic), CP 1252 (Western European), CP 1253 (Greek), CP 1255 (Hebrew).
- Powerfull central module with integrated universal inputs and with analog, triac and relay outputs.
- Each of 13 universal inputs may be alternatively used as an analog or digital input of potential free contact.
- Several inputs (AI6–AI12) may be used as current inputs 4(0)÷20 mA, the range is set by jumper. Other inputs may be configured for one of ranges Ni1000, Pt1000, OV1000. The range of measurement is set as user configuration.
- 2 SSR (Solid State Relay) outputs usable for PWM (Pulse Width Modulation).
- Memory expandable by SD/SDHC/MMC cards, built-in file system compatible with FAT32.
- Built-in clocks and calendar.
- No. of I/O is expandable up to 149 I/O, resp. up to 10 modules on high speed system serial bus TCL2 (345 kbps).
- Other I/O can be expanded also by 2 wire electrical installation bus CIB (19.2 kbps). Maximum total number of CIB branches is 9.
- On terminals CIB+ and CIB– is powered bus (max. current 100 mA).
- Optional connection of up to 4 RFox masters RF-1131 via TCL2. Radio channel 868.35 MHz.
- More PLC Tecomat can be networked by Ethernet LAN or by RS-485 bus.
- Free programmable PLC according IEC EN 61131-3.
- On-line programming during operation.
- Programming and data communication (in LAN, WiFi, WAN, Internet) is available on Ethernet port (100 Mbps) with fixed IP address or DHCP.
- Up to 3 serial ports, 1 RS-232, other with optional interface from line MR-01xx (up to 345 kbps), configurable UART. Other 6 with additional communication modules SC-1101 and SC-1102.
- Built-in PROFIBUS DP Master, Modbus RTU/TCP slave, BACnet slave on Ethernet port.
- Built-in web server, free creation of user internal web site stored on memory card (XML technology).
- Enables to create web page of any connected controlled object.
- Enables to create web page of any connected controlled object.
- May be used as a programmable converter of communication protocols.
- Compact form-factor for DIN rail mounting (9 modules width) for standard circuit breaker cabinets.

## Related products



Communication submodules MR-01xx

## Connection example

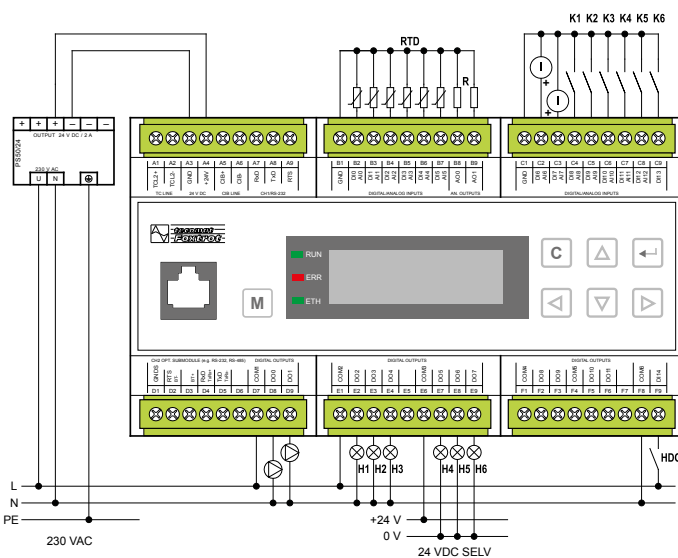

## Features of CPU

<b>CPU</b>	32 bit RISC processor
<b>PLC Instruction cycle</b>	0.2 ms/1k instructions
<b>Real Time Clock (RTC)</b>	Yes
<b>Backup period of RAM and RTC</b>	500 hours without battery 20 000 hours with battery
<b>User program memory</b>	192+64 kB
<b>Program memory backup</b>	Yes
<b>Internal data memory (DataBox)</b>	0.5 MB
<b>Archive memory for the project resource files</b>	2 MB
<b>Memory card slot</b>	Yes, MMC/SD, SDHC
<b>Memory for variables</b>	64 kB/32 kB remanent
<b>No. of IEC timers/counters</b>	4096/8192

## Communication

<b>Ethernet; supported protocols</b>	1×10/100BaseT; TCP/IP, UDP, HTTP; SMTP; MODBUS/TCP, BACnet, IEC 60870-5-104
<b>Serial ports</b>	1×RS-232; 1×free slot for optional interface (see submodules MR-0xxx)
<b>System I/O bus</b>	1×TCL2 (RS-485, 345 kbit/s)
<b>Communication over expansion module na TCL2</b>	CIB, RFox, MP-Bus, OpenTherm
<b>Installation bus</b>	1×CIB (Common installation bus 19.2 kbit/s)

Universal inputs (DI0/AI0–DI12/AI12)	
No. of inputs	13
Configurable inputs	Resistance measurement/Current measurement at digital input (see separate table)
Common wire	minus (GND)
Galvanic isolation	No

Function Analog inputs (AI0–AI12)	
Resolution	12 bit
Conversion time	50 µs/1 input
Sample repetition period	650 µs
Protection type	integrated, overvoltage

Current	
Input impedance	100 Ω
Input range	0 ÷ 20 mA (AI6–AI12) 4 ÷ 20 mA (AI6–AI12)
Max. error at 25 °C	± 0.4 % of full range
Permissible overvoltage	+50 mA (between AI and GND)
Detection of open input circuit	Yes, in status word

Resistance Temperature Detectors (RTD)	
Input impedance	> 4 kΩ
Input range	Pt1000 1.385 (–90 ÷ +270 °C) Pt1000 1.391 (–90 ÷ +270 °C) Ni1000 1.617 (–60 ÷ +155 °C) Ni1000 1.500 (–60 ÷ +155 °C) KTY81-121 (–55 ÷ 125 °C) OV1000 (0 ÷ 1000 Ω)
Max. error at 25 °C	± 0.5 % of full range
Allowed overload	–20 ÷ 30 (between AI and GND)
Sensor disconnection detection	Yes, in status word

Digital input type (DI0–DI12)	
Type of binary input	potential free contact (do not connect 24 V DC!!!)
Input voltage for log. 0 (UL)	min. 2.3 V, max. 12 V
Vstupní Voltage for log. 1 (UH)	min. 0 V, max. 1 V
Input current for log. 1 (IH)	typ. –1.7 mA
Delay 0 → 1/1 → 0	1 ms/1 ms

High speed counter DI13	
No. of counting inputs	1
Input Frequency/	5 kHz
Pulse width	min. 50 µs
Delay 0 → 1/1 → 0	10 µs/10 µs
Range	max. 32 bit; 0 ÷ 4 294 967 295
Modes	counter, pulse length measurement

Digital input 230 V AC, (DI14)	
Galvanic isolation	Yes, 4 kV
Input voltage for log.0 (UL)	max. 120 V AC
Input voltage for log.1 (UH)	min. 200 V AC;
Input current for log.1 (IH)	typ. 5 mA
Delay 0 → 1/1 → 0	10 ms/10 ms

Operating conditions	
Operating temperature	–20 ÷ +55 °C
Storage temperature	–25 ÷ +70 °C
Electric strength	according EN 60950
IP Degree of protection IEC 529	IP 20
Overvoltage category	II
Degree of pollution IEC EN 60664–1:2004	1
Working position	vertical
Installation	on DIN rail
Connections	Screw terminals
Conductors cross-section	max. 2.5 mm <sup>2</sup>

Order number	
TXN 110 06	CP-1006, CPU, ETH100/10, 1 × RS232, 1 × SCH, 13 × AI/DI, 1 × DI/230 V, 1 × HSC, 2 × AO, 10 × RO, 2 × SSR, 1 × CIB, prg. Mosaic
TXN 110 16	CP-1016, CPU+LCD4 × 20, ETH100/10, 1 × RS232, 1 × SCH, 13 × AI/DI, 1 × DI/230 V, 1 × HSC, 2 × AO, 10 × RO, 2 × SSR, 1 × CIB, prg. Mosaic

SSR outputs (Solid State Relay) (DO0–DO1)	
No. of outputs	2
Galvanic isolation	Yes
Type of output	Semiconductor switch, controlled, switch in 0
Switched voltage	min. 20 V AC, max. 260 V AC
Switched current	min. 5 mA; max. 1 A
Short-term output overload	max. 1 A
Current through joint terminal	max. 2 A
Time switching on/off contact	typ. 1 µs
Switching frequency without load	max. 400 switching/min.

Relay outputs (DO2–DO11)	
No. of outputs	3+3+2+ 2 = 10
Galvanic isolation	Yes (even groups each other)
Type of contact/type of output	Switching relay, protection free output
Switched voltage	min. 5 V; max. 250 V AC
Switched current	min. 10 mA; max. 3 A
Short-term output overload	max. 4 A
Current through common wire	max. 10 A
Time of close/open the contact	typ. 10 ms/4 ms
Threshold limits of switched loads	
for resistive load	max. 3 A at 30 V DC or 230 V AC
for inductive load DC13	max. 3 A at 30 V DC
for inductive load AC15	max. 3 A at 230 V AC
Switching frequency without load	max. 300 switching/min.
Switching frequency with rated load	max. 20 switching/min.
Mechanical/Electrical lifetime at max. load	min. 5 mil./100 000 cycles
Short-circuit protection	No
Spike suppressor of inductive load	External. (RC, varistor, diode)
Insulation voltage	3750 V AC

Analog outputs (AO0–AO1)	
No. of outputs	2
Type of output	Active voltage output
Common wire	minus (GND)
Galvanic isolation	No
Resolution	10 bit
Conversion time	10 µs/output
Max. output Current	10 mA
Output range	0 ÷ +10 V
Max. error at 25 °C	±2 % of full range
Protection type	integrated overvoltage
Permissible overvoltage	±20 V (AI against GND)

Dimensions and weight	
Dimensions	158 × 92 × 63 mm
Weight	250 g

Power supply	
Power supply voltage (SELV)	+24 V DC
Allowed range	–15 % ÷ +25 % (20.4 ÷ 30 V DC)
Max. power consumption	10 W
Galvanic isolation	No, only relay output and CH2
Memory backup	Built-in Li-Ion accumulator (500 hours) Lithium battery CR2032 holder (20 000 hours)



CP-1006



CP-1016

## Basic module with 28 I/O for use in HVAC

Type	DI	DO/RO	AI	AO	Comm
<b>CP-1008</b> <b>CP-1018</b>	1 × DI/230 VAC	4 × SSR 7 × RO	10 × AI/DI 2 × AI	4 × AO	Ethernet 10/100, RS232, 1 × optional interface, TCL2, CIB, optionally RFox

### Basic features

- Programmable controller (PLC) according to IEC EN 61131 standard.
- Outstanding integration of control system with latest IT and telecommunication technologies.
- Powerful central module with integrated mostly universal inputs (digital or analog) and with analog, relay and SSR outputs.
- Type CP-1018 is expanded with built-in display 4 × 20 characters and 6 keys. Available code pages: ASCII, CP 1250 (Central European), CP 1251 (Cyrillic), CP 1252 (Western European), CP 1253 (Greek), CP 1255 (Hebrew)..
- Each of 10 universal inputs may be alternatively used as analog or digital input (potential free contact).
- 4 of 10 universal inputs may be used as current inputs 4(0)÷20 mA, the range is set by jumper. Other inputs may be configured on one of ranges Ni1000, Pt1000, OV1000. The range of measurement is set as user configuration.
- Other 2 analog inputs may be used for connecting of thermocouples, or for voltage measurement in range 0 – 2 V.
- 6 standard 3 A relay outputs and 1 10 A output.
- 4 SSR (Solid State Relay) outputs for use of pulse control (PWM).
- Memory expandable by SD/SDHC/MMC cards, built-in file system compatible with FAT32.
- Built-in clocks and calendar.
- No. of I/O is expandable up to 148 I/O, resp. up to 10 modules on high speed internal serial bus TCL2 (345 kbps).
- Other I/O can be expanded also by 2 wire installation bus CIB (19.2 kbps). Maximum number of CIB branches is 9.
- On terminals CIB+ and CIB- is powered bus when current consumption is less than 100 mA, there is not need to use module C-BS-0001M).
- More PLC Tecomat can be networked by Ethernet LAN or by RS-485 bus.
- Free programmable PLC according IEC EN 61131-3.
- On-line programming during operation.
- Programming and data communication (in LAN, WiFi, WAN, Internet) is available on Ethernet port (100 Mbps) with fixed IP address or DHCP.
- Up to 3 serial ports, 1 RS-232, other with optional interface from line MR-01xx (up to 345 kbps), configurable UART. Other 6 with additional communication modules SC-1101 and SC-1102.
- Optional connection of RFox master RF-1131 via TCL2. Radio channel 868.35 MHz (max. 4 ×), may be combined with masters of CIB bus CF-1141.
- Built-in PROFIBUS DP Master, Modbus RTU/TCP slave, BACnet slave on Ethernet port, IEC 60870-5-104 as payed application profile.
- Built-in web server, free creation of user internal web site stored on memory card (XML technology).
- Enables to create web page of any connected controlled object.
- May be used as a programmable converter of communication protocols.
- May be used as independent programmable datalogger for any measured or internal values.
- Compact form-factor for DIN rail mounting (9 modules width) for standard circuit breaker cabinets.



CP-1008



CP-1018

### Related products



Communication submodules MR-01xx

### Connection example

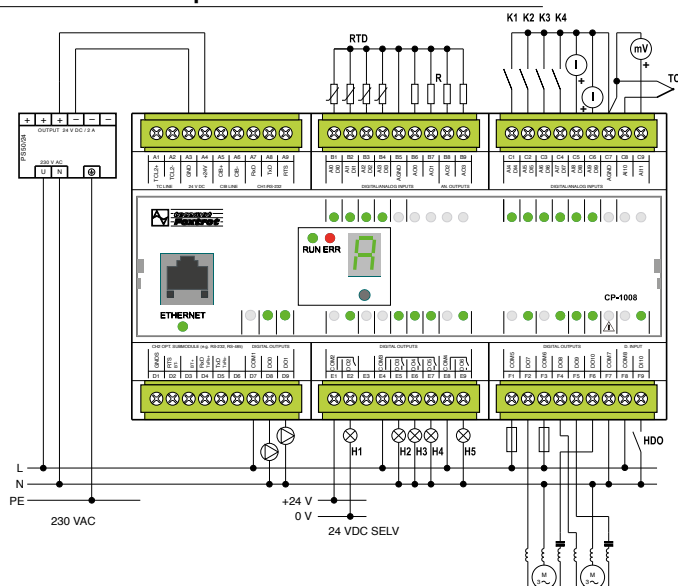

### Features of CPU

<b>CPU</b>	32 bit RISC processor
<b>PLC Instruction cycle</b>	0.2 ms/1k instructions
<b>Real Time Clock (RTC)</b>	Yes
<b>Backup period of RAM and RTC</b>	500 hours without batteries 20 000 hours with batteries
<b>User program memory</b>	192+64 kB
<b>Program memory backup</b>	Yes
<b>Internal data memory (DataBox)</b>	0.5 MB
<b>Archive memory for the project resource files</b>	2 MB
<b>Memory card slot</b>	Yes, MMC/SD, SDHC
<b>Memory for variables</b>	64 kB/32 kB remanent

### Communication

<b>Ethernet; supported protocols</b>	1 × 100/10 Mbit/s; TCP/IP, UDP, HTTP; SMTP; MODBUS/TCP, BACnet, IEC 60870-5-104
<b>Serial ports</b>	1 × RS232; 1 × free slot, optional interface (see submodules MR-0xxx).
<b>System I/O bus</b>	1 × TCL2 (RS485, 345 kbit/s)
<b>Communication over expansion module</b>	8 × CIB, 4 × RFox, MPbus, OpenTherm, GSM/SMS, GPRS
<b>Installation bus</b>	1 × CIB (19.2 kbit/s) (Common installation bus)



Universal inputs (DI0/AI0-DI9/AI9)	
No. of inputs	4 + 6
Configurable inputs	Voltage measurement/ resistance measurement/current measurement at digital input see separate table
Common wire	minus (AGND)
Galvanic isolation	No

Measurement ranges	
<b>Current</b>	
Input impedance	100 Ω
Input range	0 to 20 mA (AI4-AI9) 4 to 20 mA (AI4-AI9)
Max. error at 25 °C	±0.4% of full range
Permissible overload	+50 mA (between AI and AGND)
Detection of open input circuit	Yes in status word
<b>Resistance Temperature Detectors (RTD)</b>	
Input impedance	> 4 kΩ
Input range	Pt1000 1.385 (-90 až +270°C) Pt1000 1.391 (-90 až +270°C) Ni1000 1.617 (-60 až +155°C) Ni1000 1.500 (-60 až +155°C) KTY81-121 (-55 až +125°C) NTC 12k (-40 to +125°C) (only AI4-AI9) 0 to 2000 Ω 0 to 200 kΩ (only AI4-AI9)
Max. error at 25 °C	±0.5% of full range
Permissible overvoltage	-20 to +30 V (between AI and AGND)
Sensor disconnection detection	Yes, in status word

Function analog inputs (AI10-AI11)	
Resolution	12 bit
Conversion time	50 μs/1 input
Period of measurement	650 μs
Protection type	integrated, overvoltage

Measurement ranges	
<b>Voltage</b>	
Input impedance	> 1 GΩ
Input range	0 .. +2V 0 .. +1V -20 .. +100 mV -20 .. +50 mV
<b>Thermocouples</b>	
	J -210 to +1200 °C K -200 to +1372 °C R - 50 to +1768 °C S - 50 to +1768 °C T -200 to + 400 °C B +250 to +1820 °C N -200 to +1300 °C lambda sensor 2.85 to 21.21 %
Max. error at 25 °C	±0.4% of full range
Allowed overload	-20 to + 30 V (mezi AI and AGND)

Function Digital inputs (DI0-DI9)	
Input voltage for log. 0 (U <sub>0</sub> )	min. 2.3 V, max. 12 V
Input voltage for log. 1 (U <sub>1</sub> )	min. 0 V, max. 1 V
Input current for log. 1 (I <sub>1</sub> )	typ. -1.7 mA
Delay0 → 1/1 → 0	1 ms/1 ms

Digital input 230 V AC (DI10)	
Galvanic isolation	Yes, 4 kV
Input voltage for log.0 (U <sub>0</sub> ):	max. 120 V AC
Input voltage for log.1 (U <sub>1</sub> ):	min. 200 V AC
Input current for log.1 (I <sub>1</sub> ):	typ. 5 mA
Delay0 → 1/1 → 0:	10 ms/10 ms

Analog outputs (AO0-AO3)	
No. of outputs	4
Common wire	minus (AGND)
Galvanic isolation	No
Resolution	8 bit
Conversion time	10 μs/output
Max. output current	10 mA
Output range	0 to +10 V
Max. error at 25 °C	±2% of full range
Protection type	integrated overvoltage
Permissible overvoltage	±20 V (AI against AGND)

SSR outputs (Solid State Relay) (DO0-DO1)	
No. of outputs	2
Galvanic isolation	Yes (also among groups)
Type of output	Semiconductor switch, controlled, switching in 0
Switched voltage	max. 260 V AC
Switched current	min. 5 mA; max. 0.7 A
Current through common wire	max. 2 A
Time of close/open the contact	typ. 1 μs

Relay outputs (DO2-DO5)	
No. of outputs/groups	4/2 (1+3)
Galvanic isolation	Yes (even groups each other)
Type of contact/type of output	Switching relay, protection free output
Switched voltage	min. 5 V; max. 250 V
Switched current	min. 10 mA; max. 3 A
Short-term output overload	max. 4 A
Current through common wire	max. 10 A
Time of close/open the contact	typ. 10 ms/4 ms
<b>Threshold limits of switched loads</b>	
for resistive load	max. 3 A at 30 V DC or 230 V AC
for inductive load DC13	max. 3 A at 30 V DC
for inductive load AC15	max. 3 A at 230 V AC
Switching frequency without load	max. 300 switching/min.
Switching frequency with load	max. 20 switching/min.
Mechanic/electric service life at maximum load	min. 5 mil./100 000 cycles
Short-circuit protection	No
Spike suppressor of inductive load	External. (RC unit, varistor, diode)
Insulation voltage	3750 V AC (for details see documentation TXV 004 11)

Relay output (DO6)	
Galvanic isolation	Yes
Type of contact/type of output	Switching relay, protection free output
Switched voltage	min. 5 V; max. 250 V
Switched current	min. 10 mA; max. 10 A
Short-term output overload	max. 15 A
Time of close/open the contact	typ. 10 ms/4 ms
Switching frequency without load	max. 60 switching/min.
Switching frequency with load	max. 6 switching/min.
Mechanic/electric service life at maximum load	min. 5 mil./100 000 cycles
Short-circuit protection	No
Spike suppressor of inductive load	External. (RC unit, varistor, diode)
Insulation voltage	3750 V AC (for details see documentation TXV 004 11)

SSR outputs (Solid State Relay) (DO7, DO8)	
No. of outputs	2
Galvanic isolation	Yes (for details see documentation of TXV 004 11)
Type of output	Semiconductor switch, controlled, switching in 0)
Switched voltage	max. 260 V AC
Switched current	min. 50 mA; max. 4 A
Time of close/open the contact	typ. 1 μs



CP-1008



CP-1018

<b>Relay outputs (DO9, DO10)</b>	
No. of outputs	1+1 (switching)
Galvanic isolation	Yes (for details see documentation of TXV 004 11)
Type of contact/type of output	Switching relay, unprotected output
Switched voltage	min. 5 V; max. 250 V
Switched current	min. 10 mA; max. 3 A
Short-term output overload	max. 4 A
Time of close/open the contact	typ. 10 ms/4 ms
Switching frequency without load	max. 300 switching/min.
Switching frequency with load	max. 20 switching/min.
Mechanic/Electric service life with maximum load	min. 5 mil./100 000 cycles
Short-circuit protection	No
Spike suppressor of inductive load	External (RC, varistor, diode)

<b>Operating conditions</b>	
Operating temperature	-20 .. +55 °C
Storage temperature	-25 .. +70 °C
Electric strength	according EN 60950
IP Degree of protection IEC 529:	IP 20
Overvoltage category	II
Pollution degree IEC EN 60664-1:2004	1
Working position	vertical
Installation	on DIN rail
Connections	Screw connectors
Conductors cross-section	max. 2.5 mm <sup>2</sup>

<b>Dimensions and weight</b>	
Dimensions	158 × 92 × 63 mm
Weight	250 g

<b>Power supply</b>	
Power supply voltage (SELV)	+24 V DC
Allowed range	-15% +25% (20.4 .. 30 V DC)
Max. power consumption	10 W
Galvanic isolation	No, only relay outputs, DI10 and CH2
Memory backup	Built-in Li-Ion accumulator (500 hours). Lithium battery CR2032 holder (20 000 hours)

<b>Order number</b>	
TXN 110 08	CP-1008, CPU, ETH100/10, 1 × RS232, 1 × SCH, 10 × AI/DI, 2 × AI, 1 × DI, 4 × AO, 7 × RO, 4 × SSR, 1 × CIB, prg. Mosaic
TXN 110 18	CP-1018, CPU+LCD4 × 20, ETH100/10, 1 × RS232, 1 × SCH, 10 × AI/DI, 2 × AI, 1 × DI, 4 × AO, 7 × RO, 4 × SSR, 1 × CIB, prg. Mosaic



CP-1008



CP-1018

# PLC Foxtrot

Expansion and communication modules, CFox, RFox masters, operator panels

TCL2 – system bus, RS-485, 345 kbit/s, max. 400 m

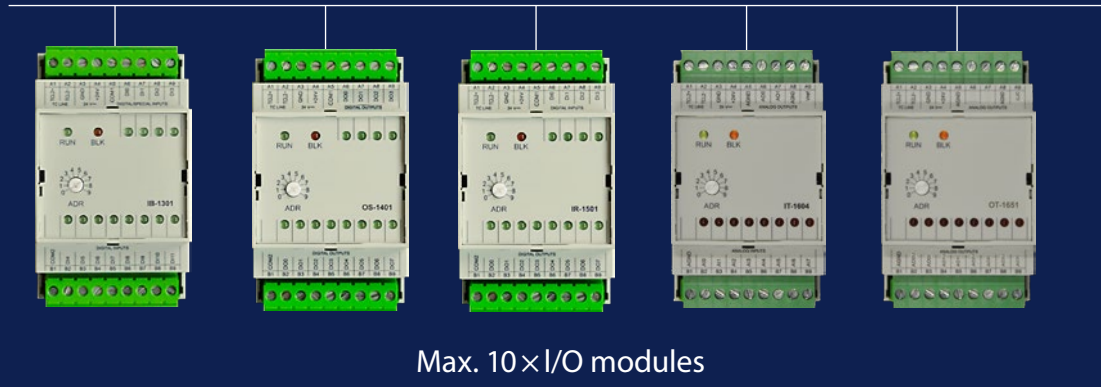

- IB-1301
- OS-1401
- IR-1501
- IT-1602
- IT-1604
- OT-1651

Max. 10 × I/O modules

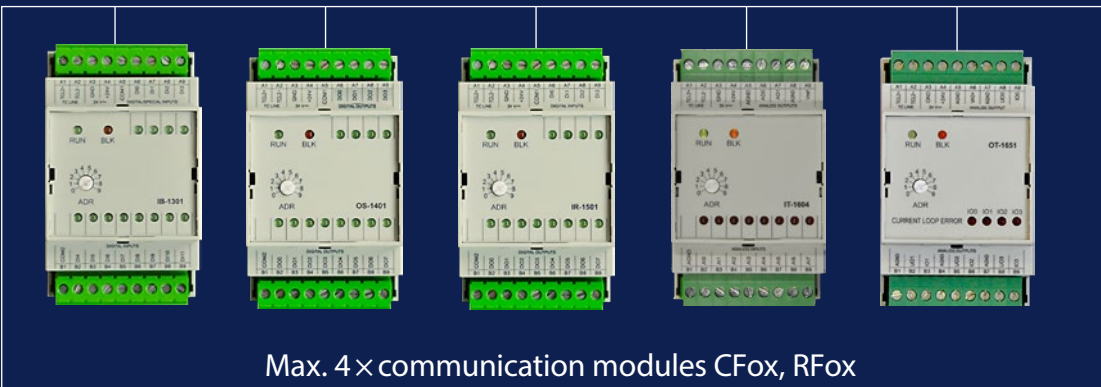

Max. 4 × communication modules CFox, RFox

- Expansion with installation bus CIB CF-1141
- and with wireless network RFox RF-1131



Max. 4 × HMI operator panel

- Graphical panel ID-17
- Character panel ID-14

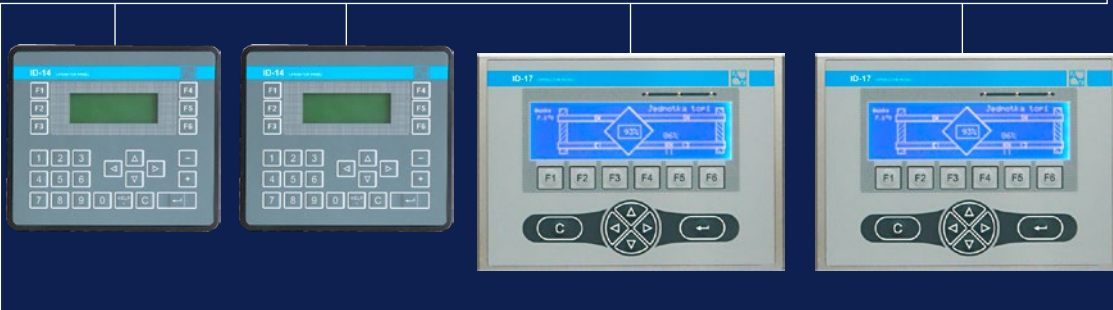

Communication modules:  
Open Therm  
MP bus (Belimo)

TCL2

TCL2 bus extension with optical fibre (up to 1700 m)



## Expansion module with binary inputs

Type	DI	RO	AI	AO	Comm
<b>IB-1301</b>	12×DI (4×HSC)				TCL2

### Basic features

- Expansion module with 12 binary inputs for enlarging I/O number of the PLC Foxtrot basic modules.
- Module is for connecting up to 12 input signals at the 24 V DC level with the common wire.
- All inputs are individually configurable.
- 4 inputs (DI0–DI3) are high-speed with the low pass filter 5 μs and can be configured for special functions identical with high speed inputs on basic module CP-1004.
- Special functions are: one or two way counters, counters with control, position incremental encoder, period and phase shift measurement up to 5 kHz and the latch for short spikes min. 50 μs.
- Status of the inputs is indicated by LED on the front panel.

### Connecting

- Compact form-factor for DIN rail mounting (3 modules width) for standard circuit breaker cabinets.
- Module can be connected to the central module directly on the distance up to 400 m by shielded twisted pair (TCL2). Using the converter KB-0552 the distance can be enlarged by fibre optic up to 1.7 km!
- Unique address of the module on TCL2 expansion bus must be set manually by the rotary switch on the front panel.
- Power supply, TCL2 and I/O are connected by removable screw connector.

### Use

- As local I/O as well as remote I/O of Tecomat Foxtrot PLC for sensing discrete sensors and switches at the 24 V DC level.
- For sensing high speed impulses up to 5 kHz.
- For sensing position incremental encoder can be connected to the module.



IB-1301

### Connection example

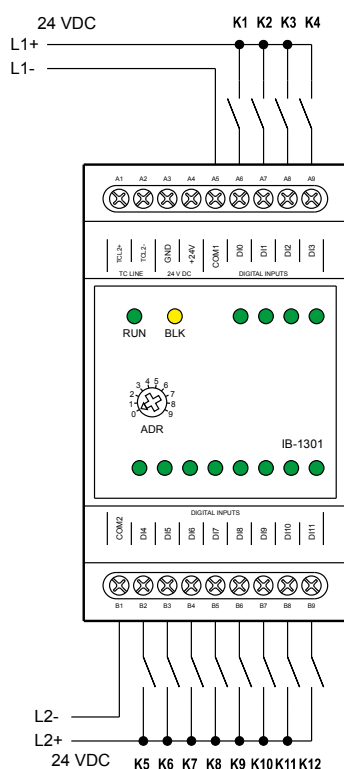

Digital inputs (DI0-DI11)	
No. of inputs in groups	8 and 4
Option: High speed counter	4 (DI0–DI3)
Common wire	minus and plus
Galvanic isolation	Yes
Input voltage for log. 0 (UL)	0 V DC; (–5 ÷ +5 V DC)
Input voltage for log. 1 (UH)	+24 V DC; (+15 ÷ +30 V DC)
Input current for log. 1 (IH)	typ. 10 mA (DI0–DI3), typ. 5 mA
Delay 0 → 1/1 → 0	5 μs/5 μs (DI0–DI3), typ. 5 mA 5 ms/5 ms (DI4–DI11)

High speed counters (DI0-DI3)	
No. of counting inputs	4
Input frequency/Pulse width	5 kHz/min. 50 μs
Delay 0 → 1/1 → 0	5 μs/5 μs
Range	max. 32 bit; 0 ÷ 4 294 967 295
Modes	One, two way counter, encoder, pulse and period measuring

Communication	
System I/O bus	1 × TCL2 (RS-485, 345 kbit/s)

### Operating conditions

Operating temperature	–20 ÷ +55 °C
Storage temperature	–25 ÷ +70 °C
Electric strength	according EN 60950
IP Degree of protection IEC 529	IP 10B
Overvoltage category	II
Degree of pollution IEC EN 60664-1:2004	1
Working position	vertical
Installation	on DIN rail
Connections	screw terminals
Conductors cross-section	max. 2.5 mm <sup>2</sup>

### Dimensions and weight

Dimensions	52 × 92 × 63 mm
Weight	105 g

### Power supply

Power supply voltage (SELV)	+24 V DC
Allowed range	–15% ÷ +25% (20.4 ÷ 30 V DC)
Max. input power	2.5 W
Galvanic isolation	No

### Order number

TXN 113 01	IB-1301, 12×DI 24 VAC/DC, galvanic isolation
------------	--

## Expansion module with binary outputs

Type	DI	DO	AI	AO	Comm
<b>OS-1401</b>		12×DO			TCL2

### Basic features

- Expansion module with 12 semiconductor outputs for enlarging I/O number of the PLC Foxtrot basic modules.
- Module is used for connecting loads at 24 V DC. Switching current is 4×2 A per output and 8×0.5 A per output.
- Galvanic isolation of outputs.
- Status of the outputs is indicated by LED on the front panel.

### Connecting

- Compact form-factor for DIN rail mounting (3 modules width) for standard circuit breaker cabinets.
- Module can be connected to the basic module directly on the distance up to 400 m by shielded twisted pair (TCL2). Using the converter KB-0552 the distance can be enlarged by fibre optic up to 1.7 km!
- Unique address of module on TCL2 expansion bus must be set manually by the rotary switch on the front panel.
- Power supply, TCL2 and I/O are connected by removable screw connector.

### Use

- As local I/O as well as remote I/O of Tecomat Foxtrot PLC.
- For switching loads by semiconductor at 24 V DC level.



OS-1401

### Connection example

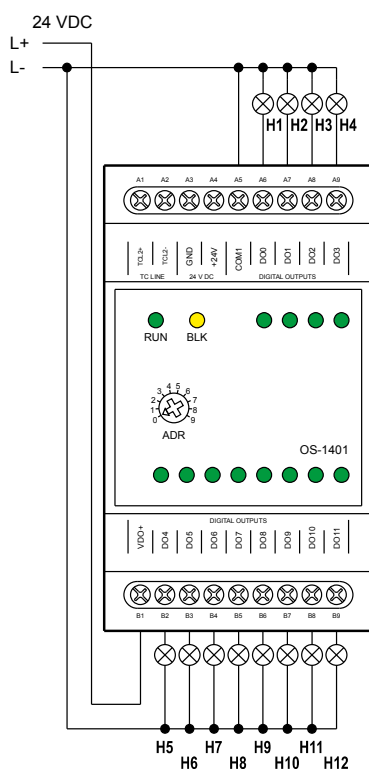

Binary outputs (DO0–DO11)	
No. of outputs	12
Galvanic isolation	Yes
Type of output	Transistor
Common wire	Plus
Switched voltage	9.6–28.8 V DC
Switched current	max. 2 A ((DO0–DO3)) max. 0.5 A (DO4–DO11)
Current through joint terminal	max. 9 A (DO0–DO11) max. 4.4 A (DO0–DO3)
Cut-off current	<300 µA
Time of close/open the contact	400 µs/400 µs
Short-circuit protection/Short circuit current limitation	Yes/<4 A
Reversing of polarity protection	Yes
Spike suppressor of inductive load	External RC, varistor or diode snubber

Communication	
System I/O bus	1 × TCL2 (RS-485, 345 kbit/s)

### Operating conditions

Operating temperature	–20 ÷ +55 °C
Storage temperature	–25 ÷ +70 °C
Electric strength	according EN 60950
IP Degree of protection IEC 529	IP 10B
Overvoltage category	II
Degree of pollution IEC EN 60664-1:2004	1
Working position	vertical
Installation	on DIN rail
Connections	screw terminals
Conductors cross-section	max. 2.5 mm <sup>2</sup>

### Dimensions and weight

Dimensions	52×92×63 mm
Weight	100 g

### Power supply

Power supply voltage (SELV)	+24 V DC
Allowed range	–15% ÷ +25% (20.4 ÷ 30 V DC)
Max. input power	2.5 W
Galvanic isolation	No

### Order number

TXN 114 01	OS-1401, 12×DO 24 VDC, 8×0.5 A, 4×2 A, galvanic isolation
------------	---

## Expansion module with binary inputs and relay outputs

Type	DI	RO	AI	AO	Comm
<b>IR-1501</b>	4×DI	8×RO			TCL2

### Basic features

- Expansion module with 4 binary inputs and 8 relay outputs for enlarging I/O number of the PLC Tecomat Foxtrot basic modules.
- Inputs are individually configurable.
- 4 inputs (DI0-DI3) are high-speed with the low pass filter 5 μs and can be configured for special functions identical with high speed inputs on the basic module CP-1004.
- Special functions are: one or two way counters, counters with control, position incremental encoders, period and phase shift measurement up to 5 kHz and latch for short spikes min. 50 μs.
- Galvanic isolation of inputs and outputs.
- Status of the inputs and outputs is indicated by LED on the front panel.

### Connection example

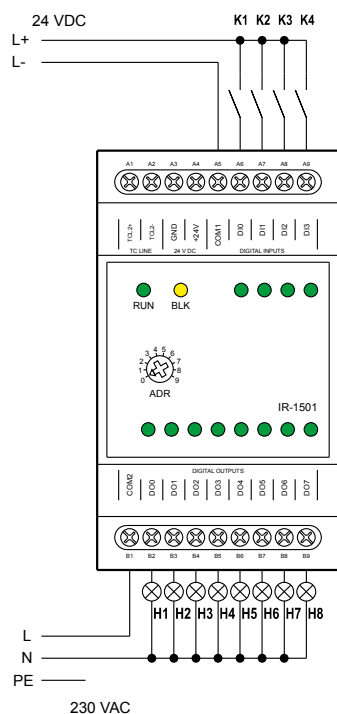

Digital inputs (DI0–DI03)	
No. of inputs × groups	4 × 1
Option: High speed counter	4 (DI0–DI3)
Common wire	minus/plus
Galvanic isolation	Yes
Input voltage for log. 0 (UL)	0 V DC; (–5 ÷ +5 V DC)
Input voltage for log. 1 (UH)	+24 V DC; (+15 ÷ +30 V DC)
Input current for log. 1 (IH)	typ. 10 mA
Delay 0 → 1/1 → 0:	5 μs/5 μs (DI0–DI3)

### Operating conditions

Operating temperature	–20 ÷ +55 °C
Storage temperature	–25 ÷ +70 °C
Electric strength	according EN 60950
IP Degree of protection IEC 529	IP 10B
Overvoltage category	II
Degree of pollution IEC EN 60664-1:2004	2
Working position	vertical
Installation	on DIN rail
Connections	screw terminals
Conductors cross-section	max. 2.5 mm <sup>2</sup>

### Order number

TXN 115 01 IR-1501, 4×DI 24 V AC/DC, 8×RO, common wire, 230 V/2 A, galvanic isolation

### Connecting

- Compact form-factor for DIN rail mounting (3 modules width) for standard circuit breaker cabinets.
- Module can be connected to the central module directly on the distance up to 400 m by shielded twisted pair (TCL2). Using the converter KB-0552 the distance can be enlarged by fibre optic up to 1.7 km!
- Module address on TCL2 expansion bus must be set manually by the rotary switch on the front panel.
- Power supply, TCL2 and I/O are connected by removable screw connector.

### Use

- As local I/O as well as remote I/O of PLC Tecomat Foxtrot
- For switching loads by relay contacts for 24 V DC or 230 V AC level.
- For sensing discrete sensors and switches at the 24 V DC level.
- For sensing high speed impulses up to 5 kHz.
- For sensing position incremental encoders.

### High speed counters (DI0–DI3)

No. of counting inputs	4
Input Frequency/Pulse width	5 kHz/min. 50 μs
Delay 0 → 1/1 → 0	5 μs
Range	max. 32 bit; 0 ÷ 4 294 967 295
Modes	One, two way counter, encoder, pulse and period measuring

### Relay outputs (DO0–DO7)

No. of outputs × groups	8 × 1
Galvanic isolation	Yes
Type of contact/type of output	Electromechanical relay, non-protected output
Switched voltage	min. 5 V; max. 250 V
Switched current	min. 100 mA; max. 3 A
Short-term output overload	max. 4 A
Current through joint terminal	max. 10 A
Time of close/open the contact	typ. 10 ms/4 ms

### Threshold limits of switched loads

for resistive load	max. 3 A /30 V DC nebo 230 V AC
for inductive load DC13	max. 3 A /30 V DC
for inductive load AC15	max. 3 A /230 V AC
Switching frequency without load	max. 300 ×/min.
Switching frequency with rated load	max. 20 ×/min.
Mechanical/Electrical lifetime at max. load	min. 5 mil./100 thous. cycles
Short-circuit protection	None
Spike suppressor of inductive load	External RC, varistor or diode snubber
Insulation voltage	3750 V AC/3750 V AC

### Communication

System I/O bus	1 × TCL2 (RS-485, 345 kbit/s)
----------------	-------------------------------

### Dimensions and weight

Dimensions	52 × 92 × 63 mm
Weight	150 g

### Power supply

Power supply voltage (SELV)	+24 V DC
Allowed range	–15% +25% (20.4 ÷ 30 V DC)
Max. input power	3 W
Galvanic isolation	No



IR-1501

## Expansion modules with analog inputs and outputs

Type	DI	DO	AI	AO	Comm
<b>IT-1604</b>					
<b>IT-1602</b>			8×AI	2×AO	TCL2

### Basic features

- Modules with combination of analog galvanic isolated inputs and outputs (AI/AO).
- IT-1604 is designed for 16 bit current, voltage and resistance /RTD measurement. Built-in reference voltage supply.
- IT-1602 is designed for 16 bit thermocouples measurement and low voltage measurement.
- Inputs are independent configurable.
- Type and range of measurement is set in user configuration.
- Built-in temperature sensor linearisation and correction of cold end thermocouple correction.
- Analog voltage outputs, 10 bit
- Output value provided in binary code, in % of range or directly in volts.

### Connection example

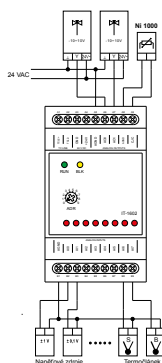

### Communication

System I/O bus	1 × TCL2 (RS-485, 345 kbit/s)
----------------	-------------------------------

### Analog inputs (AI0–AI7)

No. of inputs × groups	8 × 1
Configurable inputs	Voltage measurement/resistance measurement/current measurement at binary input see separate table
Common wire	minus (AGND)
Galvanic isolation	Yes
Resolution	16 bit
Conversion time	65 ms/(IT-1604), 100 ms (IT-1602)
Sample repetition period	500 ms
Protection type	integrated, overvoltage

### Analog outputs

No. of outputs × groups	2 × 1
Common wire	minus (AGND)
Galvanic isolation	Yes
Resolution	10 bit
Conversion time	10 μs/output
Max. output current	10 mA
Output range	0 ÷ +10 V (IT-1604), +–10 V (IT-1602)
Max. error at 25 °C	±2% of full range
Protection type	integrated, overvoltage
Allowed overload	±20 V (AI against AGND)

### Operating conditions

Operating temperature	–20 ÷ +55 °C
Storage temperature	–25 ÷ +70 °C
Electric strength	according EN 60950
IP Degree of protection IEC 529	IP 10B
Overvoltage category	II
Degree of pollution IEC EN 60664-1:2004	1
Working position	vertical
Installation	on DIN rail
Connections	connector/screw terminals
Conductors cross-section	max. 2.5 mm <sup>2</sup>

### Order number

TXN 116 04	IT-1604, 8×AI 16 bit/20 mA/10 V/RTD, 2×AO 10 bit/0÷10 V, galvanic isolation
TXN 116 02	IT-1602, 8×AI 16 bit,J,K,R,S,B,N,T, ± 1 V 2×AO 10 bit/±10 V, galvanic isolation

- Overload or disconnecting on input (only for 4–20 mA range) is indicated on front panel.

### Connection

- Module designed for DIN rail mounting for standard circuit breaker cabinets.
- Module can be connected to the central module directly on the distance up to 400 m by shielded twisted pair (TCL2). Using the converter KB-0552 the distance can be enlarged by fibre optic up to 1.7 km!
- Unique module address on TCL2 expansion bus must be set manually by the rotary switch on the front panel.
- Power supply, TCL2 and I/O are connected by removable screw connector.

### Use

- For expand the number of Tecomat Foxtrot basic module I/O.
- For precise measurement of voltage and current signals and for direct measurement of resistance sensors and thermocouples.

### Measurement ranges IT-1604

<b>Voltage</b>	
Input impedance	> 100 kΩ (0,5 V, 1 V; 2 V) > 50 kΩ (5 V; 10 V)
Input range	0 ÷ +10 V; 0 ÷ +5 V 0 ÷ +2 V; 0 ÷ +1 V, 0 ÷ 0,5 V
Max. error at 25 °C	±0.3% of full range
Permissible overvoltage	±30 V (between AI and AGND)
<b>Current</b>	
Input impedance	100 Ω
Input range	0 ÷ 20 mA; 4 ÷ 20 mA; 0 ÷ 5 mA
Max. error at 25 °C	±0.4% of full range
Allowed overload	+30 mA (between AI and AGND)
Detection of open input circuit	Yes, in status word and by LED
<b>Resistance Temperature Detectors (RTD) (RTD)</b>	
Input impedance	7.5 kΩ
Input range	Pt100 1.385 (–90 ÷ +400 °C) Pt100 1.391 (–90 ÷ +400 °C) Pt1000 1.385 (–90 ÷ +400 °C) Pt1000 1.391 (–90 ÷ +400 °C) Ni1000 1.617 (–60 ÷ +200 °C) Ni1000 1.500 (–60 ÷ +200 °C) OV1000 (0 ÷ 1000 Ω), OV100 (0 ÷ 100 Ω), 0 ÷ 2 kΩ, 0 ÷ 200 kΩ, NTC 12k, KTY81-121
Max. error at 25 °C	± 0.5% of full range
Sensor disconnection detection	Yes, in status word

### Measurement ranges IT-1602

<b>Voltage</b>	
Input impedance	> 1 MΩ
Input range	–1 ÷ +1 V; –0.1 ÷ +0.1 V
Max. error at 25 °C	±0.3% of full range
Permissible overvoltage	±35 V (between AI a AGND)
<b>Thermocouples</b>	
Input impedance	>1 MΩ
Input range	J, K, R, S, B, N, T
Max. error at 25 °C	±0.5% of full range
Sensor disconnection detection	No

### Dimensions and weight

Dimensions	52 × 92 × 63 mm
Weight	120 g

### Power supply

Power supply voltage (SELV)	+24 V DC
Allowed range	–15% ÷ +25% (20.4 ÷ 30 V DC)
Max. input power	IT-1604 2.5 W; IT-1602 2.5 W
Galvanic isolation	No



IT-1604



IT-1602

## Expansion module with analog outputs

Typ	DI	DO	AI	AO	Comm
<b>OT-1651</b>				4×AO (U/I)	TCL2

### Basic features

- Module with 4 independent output analog channels, galvanic isolated.
- Each channel has an outlet both for voltage and at neighboring terminal for current output too.
- Output voltage resolution is 10 bit.
- Each channel is independently addressed and controlled in range 0 – 100% of current range.
- Type and output range is set in user configuration.
- Status is indicated by LED on module.

### Connection

- Module is designed for DIN rail mounting for standard circuit breaker cabinets.
- Module can be connected to the central module directly

- on the distance up to 400 m by shielded twisted pair (TCL2).
- Unique module address on TCL2 expansion bus must be set manually by the rotary switch on the front panel.
- Module is power supplied like other modules from 24 V DC power supply, connected to removable screw connector.

### Use

- Module is designed for connecting devices controlled by DC voltage or current like frequency drives, proportional valves or light dimmers.



OT-1651

### Connection example

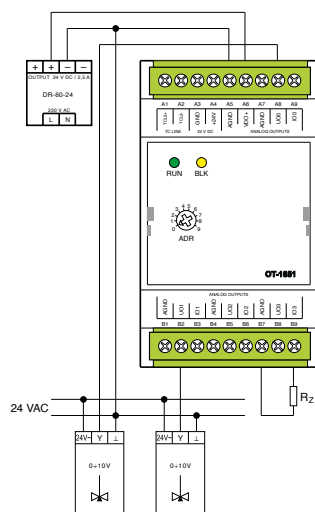

### Analog outputs (AO0U-AO3U), (AO0I-AO3I)

No. of outputs	4
Active voltage/current output	
Common wire	Minus (AGND)
Galvanic isolation	Yes
Resolution	12 bit
Conversion time	10 μs/output
Napájecí napětí	+V <sub>AO</sub> 24 V DC
Max. output current	10 mA
Output voltage range	0 – 10 V
Output current range	0 – 20 mA
Max. error at 25°C	± 0,3 % of full range
Protection type	–1 V to (V <sub>AO</sub> + 1) V

### Operating conditions

Operating temperature	–20 .. +55 °C
Storage and transport temperature	–25 .. +70 °C
Electric strength	according EN 60950
IP Degree of protection(IEC 529)	IP10B
Overvoltage category	II
Pollution degree IEC EN 60664-1:2004	2
Working position	vertical
Installation	on DIN rail
Connections	removable screw type connector, max. 2,5 mm <sup>2</sup>

### Communication

System bus	1 × TCL2 (RS-485, 345 kbit/s)
------------	-------------------------------

### Dimensions and weight

Dimensions	52×92×63 mm
Weight	120 g

### Power supply modulu

Power supply	24 V DC
Allowed range	–15 % +25 % (20,4 – 30 V DC)
Max. input power	0,3 W
Max. výkonová ztráta modulu	4,4 W
Galvanic isolation	Yes

### Order number

TXN 116 51	OT-1651, 4×AO 12 bit, 0 – 10 V, 0 – 20 mA, galvanic isolation
------------	---



# PLC Foxtrot

## Communication modules

### Modules for empty slot in basic module



MR-0104  
RS-232



MR-0114  
RS-485  
(Profibus DP  
master)



MR-0124  
RS-422



MR-0105  
2xRS-232  
1xRS-485



MR-0106  
1xRS-232  
2xRS-485  
(2xDMX512)



MR-0115  
3xRS-485  
(2xDMX512)



MR-0152  
Profibus DP  
slave



MR-0161  
1xCAN bus



MR-0158  
M-bus



MX-0301  
Wiegand

### Modules on system bus TCL2



CF-1141  
2xCIB master



RF-1131  
1xRFox  
master



UC-1203  
Open  
Therm  
master



UC-1204  
1xMP bus  
Belimo



KB-0552  
TCL2/ mm  
optické  
vlákno



SX-1162  
5x port Tx



105FX  
4x port TX  
1x port FX



306FX2  
4x port TX  
2x port FX

### Routers – connected via LAN



URS V2 Full  
UMTS router



ER75i V2 Full  
GPRS/EDGE router



UC-1205  
GSM gateway



INSYS  
GSM Small



SX-1181  
M-Bus



SMM-33  
Multifunctional  
measurement  
of 3 phase network

### Modules connected via RS-232/RS-485

## Submodules with communication interface

Type	DI	DO	AI	AO	Comm
<b>MR-0104</b>					RS-232
<b>MR-0114</b>					RS-485
<b>MR-0124</b>					RS-422
<b>MR-0105</b>					2×RS-232, 1×RS-485
<b>MR-0106</b>					1×RS-232, 2×RS-485
<b>MR-0115</b>					3×RS-485
<b>MR-0152</b>					Profibus DP Slave
<b>MR-0158</b>					M-Bus
<b>MR-0160</b>					2×CAN
<b>MR-0161</b>					1×CAN
<b>MX-0301</b>					Wiegand

### Basic features

- Submodules (piggybacks) MR-01xx are designed to be inserted in slot CH2. These submodules can enlarge communication flexibility of the Foxtrot basic modules.
- Selection of interface module is a selection of the physical layer of communication. The higher layers as protocols and communication modes can be set in configuration tool of Mosaic.

### Connecting

- Submodules are inserted in the slot which is inside the basic module.
- The basic module has to be opened. The slot is placed on the CPU PCB.
- The module has to be placed on the free pins of slot in proper orientation.
- The signal layout of terminals is a part of documentation of each submodule.

### Use

- In all cases where Foxtrot has to be adapted to communicate with other device or with other Foxtrot.

Specification	MR-0104	MR-0105	MR-0106	MR-0115	MR-0114	MR-0124
<b>Interface</b>	RS-232	2×RS-232, 1×RS-485	1×RS-232, 2×RS-485	3×RS-485	RS-485	RS-422
<b>Galvanic isolation (GO)</b>	Yes	Yes	Yes	Yes	Yes	Yes
<b>Insulation voltage GO</b>	1000 V DC	1000 V DC	1000 V DC	1000 V DC	1000 V DC	1000 V DC
<b>Max. comm. rate</b>	200 kBd	200 kBd	200 kBd	2 MBd	2 MBd	2 MBd
<b>Receiver input impedance</b>	Min. 7 kΩ	Min. 7 kΩ	Min. 7 kΩ	Sensitivity ±200 mV	Sensitivity ±200 mV	Sensitivity ±200 mV
<b>Transmitter output level</b>	±8 V	±8 V	±8 V	Typ 3.7 V	Typ 3.7 V	Typ 3.7 V
<b>Max. distance of wiring</b>	15 m	15 m	15 m	1200 m	1200 m	1200 m

Specification	MR-0152	MR-0158	MR-0160/0161	MX-0301
<b>Interface</b>	Profibus DP Slave	M-Bus, Master interface for connection of up to 20 meters (heat etc.)	2×CAN/ 1×CAN	Wiegand
<b>Galvanic isolation (GO)</b>	Yes	Yes	Yes	No
<b>Insulation voltage GO</b>	1000 V DC	1000 V DC	1000 V DC	–
<b>Max. comm. rate</b>	12 MBit/s	9.6 kbit/s	0.5 Mbit/s	–
<b>Receiver input impedance</b>	Sensitivity ±200 mV		+200 mV	TTL
<b>Transmitter output level</b>	Typ 3.7 V	Converter output voltage 36 V/55 mA	Typ 5 V	24 V(max.29 V)/max. 100 mA, open collector
<b>Max. distance of wiring</b>	1200 m (<187 kbit/s)	350 m	100 m	1m

### Order number

<b>TXN 101 04</b>	MR-0104, RS-232 with galvanic isolation and with power supply
<b>TXN 101 14</b>	MR-0114, RS-485 with galvanic isolation and with power supply
<b>TXN 101 24</b>	MR-0124, RS-422 with galvanic isolation and with power supply
<b>TXN 101 05</b>	MR-0105 2×RS-232, 1×RS-485 with galvanic isolation and with power supply
<b>TXN 101 06</b>	MR-0106 1×RS-232, 2×RS-485 with galvanic isolation and with power supply
<b>TXN 101 15</b>	MR-0115 3×RS-485 with galvanic isolation and with power supply
<b>TXN 101 52</b>	MR-0152, PROFIBUS DP Slave with galvanic isolation and with power supply
<b>TXN 101 58</b>	MR-0158, M-Bus Master pro až 20 stanic Slave with galvanic isolation and with power supply
<b>TXN 101 60</b>	MR-0160, 2×CAN (SJA1000, Philips) with galvanic isolation and with power supply
<b>TXN 101 61</b>	MR-0161, 1×CAN (SJA1000, Philips) with galvanic isolation and with power supply
<b>TXN 103 01</b>	MX-0301, connection of Wiegand card reader



MR-0104, RS-232  
MR-0114, RS-485  
MR-0124, RS-422

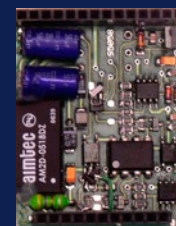

MR-0158 M-Bus  
MR-0161, 2×CAN



MR-0152, Profibus



## Submodules with binary inputs and outputs

Type	DI	DO	AI	AO	Comm
<b>PX-7811</b>	7×DI				
<b>PX-7812</b>	4×DI	3×DO			

### Basic features

- Submodules PX-781x are designed to be inserted in slot CH2. These submodules can enlarge number of I/O on the Foxtrot basic module.
- Inserting PX-781x in the slot excludes using the communication interface at the same time.
- For Foxtrot (excluding CP-10×6 and CP-10×8) PX-7811 enables to add 7 binary inputs. PX-7812 enables to add 4 binary inputs and 3 binary outputs.

### Connecting

- The basic module must be opened. The slot is placed on the CPU PCB which is at the midaccording inside PCB.
- The module has to be placed on the free pins of slot in proper orientation.

### Use

- In case of applications where more I/O are needed and no other serial communication is required.



PX-7811



PX-7812

### Connection example PX-7811

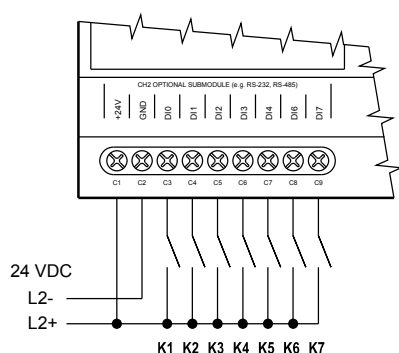

### Connection example PX-7812

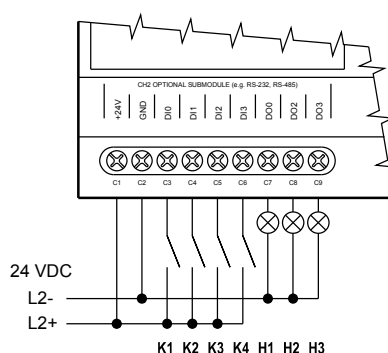

Binary inputs	PX-7811	PX-7812
No. of inputs	8 <sup>1)</sup>	4
Common wire	minus (GND)	minus (GND)
Galvanic isolation	Yes	Yes
Input voltage for log. 0 (UL)	0V DC; (-15 ÷ +5 V DC)	0V DC; (-15 ÷ +5 V DC)
Input voltage for log. 1 (UH)	+24V DC; (+11 ÷ +30V DC)	+24V DC; (+11 ÷ +30V DC)
Input current for log. 1 (IH)	typ. 3 mA	typ. 3 mA
Delay 0 → 1/1 → 0:	5ms/5ms	5ms/5ms

<sup>1)</sup> for Foxtrot can be used 7

Binary outputs	PX-7812
No. of outputs	4 <sup>2)</sup>
Galvanic isolation	Yes
Type of output	Transistor, protected output
Common wire	Minus (GND)
Switched voltage	11 – 30V DC
Switched current	max. 0.5 A
Current through common wire	max. 2 A
Cut-off current	max. 300 µA
Time of close/open the contact	400 µs/400 µs
Short-circuit protection/ /Short circuit current limitation	Yes, internal/<1.1 A
Reversing of polarity protection	Yes
Spike suppressor of inductive load	External (RC circuit, varistor, diode)

<sup>2)</sup> for Foxtrot can be used 3

### Order number

TXN 178 11	PX-7811, 8×DI (7×DI for Foxtrot), 24V DC, galvanic isolation, autoidentification
TXN 178 12	PX-7812, 4×DI, 4×DO (3×DO for Foxtrot) 24V DC/0.5 A, galvanic isolation, autoidentification

## MP-Bus and OpenTherm communication

Type	DI	DO	AI	AO	Comm
<b>UC-1203</b>					TCL2, MP-Bus
<b>UC-1204</b>					TCL2, OpenTherm

### Basic features

- The module **UC-1203** is designed for the Tecomat Foxtrot basic module as communication channels expansion by Belimo's company MP-Bus that is used for valve drives and air-condition shutters control.
- MP-Bus is supplied from 24 V DC/AC.
- Up to 8 Belimo MFT drives can be driven by one bus.
- UC-1203 can read 1 temperature sensor (RTD Ni1000, Pt1000, resistance transmitter 1000 Ω) or contact connected to each drive.
- Measured temperature (or contact status) is transferred to the system and it is available as standard analog (binary) input.
- The module **UC-1204** is designed for the Tecomat Foxtrot basic module for bidirectional communication with boilers equipped with OpenTherm interface/protocol.
- Supported protocol** both OT/+ (OpenTherm/plus) and OT/- (OpenTherm/Lite).

### Connection

- Designed for the installation on DIN rail.
- Modules are realized as TCL2 bus communication expansion modules.
- UC-1203 MP-Bus module installation: for recommended cables and lengths see MP-Bus specification (Belimo company manuals)
- UC-1204 OpenTherm module installation: 2-wire cable, not twisted, 50 m at max., cable resistance  $2 \times 5 \Omega$ , any polarity.

### Use

- It can be used in measuring and control tasks and in building management systems (HVAC).

### Connection example UC-1203 (MP-Bus)

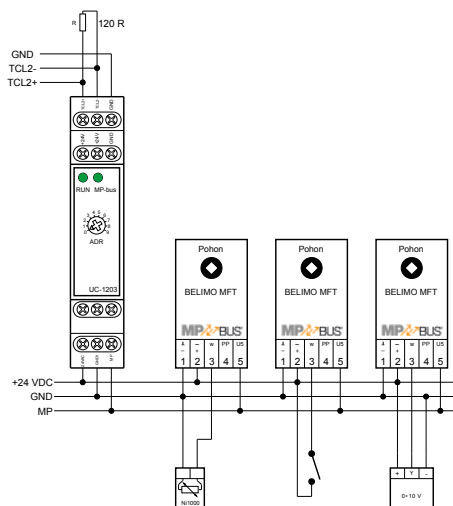

### Connection example UC-1204 (OpenTherm)

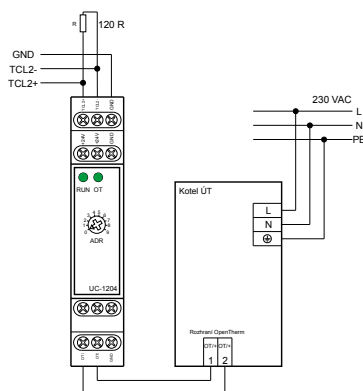

Communication	UC-1203	UC-1204
<b>System I/O bus</b>	1 × TCL2 (RS-485, 345 kbit/s) up to distance 400 m, without branches, impedance termination	
<b>Installation bus/protocol</b>	MP Bus	OpenTherm

### Operating conditions

<b>Operating temperature</b>	-20 ÷ +55 °C
<b>Storage temperature</b>	-25 ÷ +70 °C
<b>Electric strength</b>	according EN 60950
<b>IP Degree of protection IEC 529</b>	IP 20
<b>Overvoltage category</b>	II
<b>Degree of pollution IEC EN 60664-1:2004</b>	1
<b>Working position</b>	any
<b>Installation</b>	On DIN rail
<b>Connections</b>	Screw terminals
<b>Conductors cross-section</b>	max. 2.5 mm <sup>2</sup>

### Dimensions and weight

<b>Dimensions</b>	90 × 18 × 65 mm
<b>Weight</b>	75 g

### Power supply

<b>Power supply voltage (SELV)</b>	+24 V DC
<b>Allowed range</b>	-15% ÷ +25% (20.4 ÷ 30 V DC)
<b>Max. input power</b>	2.5 W, (UC-1203), 0.4 W (UC-1204)
<b>Galvanic isolation</b>	Yes



UC-1203



UC-1204

### Order number

<b>TXN 112 03</b>	UC-1203, MP-Bus – Communication module for Belimo's servodrive connection
<b>TXN 112 04</b>	UC-1204, OpenTherm – Communication module for boilers connection

# GSM gateway for SMS communication

Typ	DI	RO	AI	AO	Comm
<b>UC-1205</b>					RS232/ GSM(SMS)

## Basic features

- GSM gateway - Quad-band – operates in bands 800/900 and 1800/1900MHz
- Designated for monitoring and commanding of system Tecomat Foxtrot via SMS messages from a mobile phone.
- Fixing on DIN rail with permanent connection by screw terminals.

## Connection

- Power supply is connected by screw terminals.
- Serial channel RS-232 is connected by screw terminals.
- SIM card has to be inserted to a slot placed at the front side.

- External antenna can be connected via SMA connector either to directly module or via cable to an optimal place, e.g. outside the switching cabinet.
- Antenna is not a part of the module and has to be ordered separately.

## Use

- Module is designated as both direction communication gateway of system Tecomat Foxtrot to GSM networks.
- In parametrization software FoxTool can be set up to 48/32 incoming/outgoing SMS messages, 32 different phone numbers (where to send SMS messages), maximum number of outgoing SMS messages for a chosen time period, etc.
- There is available library function for sending and receiving SMS messages that can be used in programming software Mosaic.
- In Mosaic software we may use module as data modem controlled by AT commands.



UC-1205

Foxtrot

## Connection example

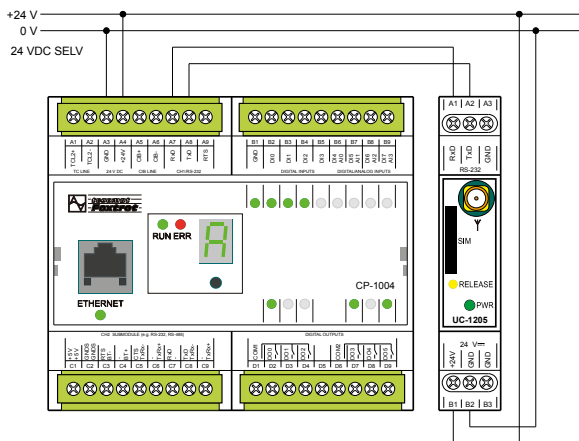

## Communication

Connection to basic module serial channel	1× RS232
GSM network	Quad Band EGSM 800/900 MHz, GSM 1800/1900 MHz

## Operating conditions

Operating temperature	-20 .. +55 °C
Storage temperature	-25 .. +70 °C
Electric strength	according EN 60730
IP Degree of protection IEC 529	IP20
Overvoltage category	II
Degree of pollution ČSN EN60664-1:2008	1
Working position	Vertical
Installation	On DIN rail
Power supply and RS-232 connection	Screw terminals, diameter of wire max. 4mm <sup>2</sup> .

## Dimensions and weight

Dimensions	95 × 65 × 17,7 mm
Weight	70 g

## Power supply

Power supply and communication	24 V DC
Input power during transmitting	6 W
Internal protection	No

## Order number

TXN 112 05	UC-1205, GSM gateway – bands 800/900, 1800/1900 MHz (quad-band)
------------	---

## TCL2 bus optical interconnection module

Type	DI	DO	AI	AO	Comm
<b>KB-0552</b>					TCL2 MM Optic Fibre

### Basic features

- The module is designed for TCL2 bus protocol conversion from metallic wires – RS-485 to the multimode optical fibre and it is conform with the bus transfer speed 345 kbps.
- Using more converters on one TCL2 bus allows to create star topology which lines are created by optical fibres.

### Connection

- The module is connected to the power supply and TCL2 bus by screw-type terminals.
- A pair of optical fibres MM (multimode) is connected by ST connectors. The length of the optical cable is up to 1750 m.

### Use

- A pair of KB-0552 modules allows to connect Foxtrot system bus by optical fibres with ST connectors.
- The module is designed for installations where it is necessary to use galvanically separated connection that eliminates electromagnetic disturbance influence, it means mainly for outside installations, industrial plants etc.



KB-0552

### Connection example

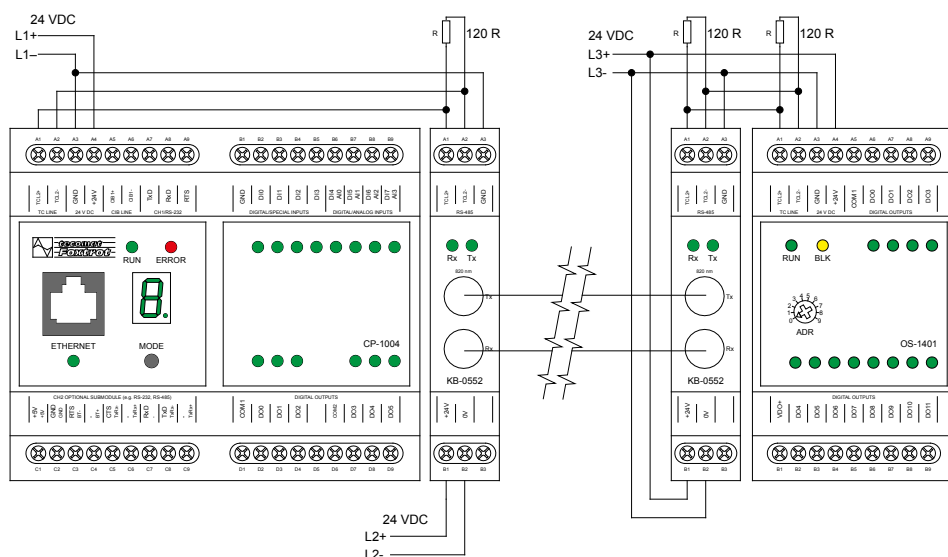

### Communication

System I/O bus	1 × TCL2 (RS-485, 345 kbit/s)
Communication medium	multimode glass fibre
Optic fibre connection	ST connector
Optical radiation wave length	820 nm
Ultimate operating range of 62.5/125 mm fibre	15 dB, min. 8 dB
Transmitter optical output	-12 dBm, min. -15 dBm
Total optical output	0.355 mW
Optical power input, log 0" (0-70 °C)	-24.0 ÷ -10.0 dBm
Optical power input, log 0" (25 °C)	-25.4 ÷ -9.2 dBm
Optical power input, log 1"	Max. -40 dBm

### Optical cables – other parameters

Operating temperature	-40 ÷ 80 °C
Temperature during installation	0 ÷ 70 °C
Cable attenuation per 1 km of the length	3.5 dBm
Delay given by propagation velocity	5 ns/m
Cable extrinsic diameter (2 fibres)	3 ÷ 6 mm

### Operating conditions

Operating temperature	-20 ÷ +55 °C
Storage temperature	-30 ÷ +70 °C
Electric strength	according EN 60950
IP Degree of protection IEC 529	IP 20
Overvoltage category	III
Degree of pollution IEC EN 60664-1:2004	2
Working position	any
Installation	On DIN rail
Connections of optic fibre	Duplex 2 × ST
Connections others	Screw terminals
Conductors cross-section	max. 2.5 mm <sup>2</sup>

### Dimensions and weight

Dimensions	90 × 18 × 65 mm
Weight	75 g

### Power supply

Power supply voltage (SELV)	+24 V DC
Allowed range	-15% ÷ +25% (20.4 ÷ 30 V DC)
Max. input power	0.25 W
Galvanic isolation	No

### Order number

TXN 105 52	KB-0552, TCL2 converter to multimode glass optic fibre
------------	--

## Ethernet switch 10/100BaseTX

Type	DI	RO	AI	AO	Comm
<b>SX-1162</b>					5 × 10/100BaseTX

### Basic features

- 5 × UTP ports 10BaseT/100BaseTX according the standard IEEE 802.3.
- Housing designed for the DIN rail installation and into standard switchboards.
- Can be connected together to create bigger LAN.
- Protocol/functions supported.
  - All protocols based on Ethernet.
  - Auto-MDIX.
  - Internal table for 2000 MAC addresses.
  - Filter for non-valid packets.
  - Security functions according 802.1x.
  - Protection against broadcast and multicast storm (Port overflow).

### Connection

- RJ45 connector for standard UTP CAT5 cables.
- Screw terminals for 24 V DC power supply.

### Use

- Switch is designed to create small LAN of devices compatible with 10/100baseTX just centralized in electrical switch board, together with Foxtrot basic modules

### Operating conditions

Operating temperature	0 ÷ +55 °C
Storage temperature	–25 ÷ +70 °C
Electric strength	according EN 60950
IP Degree of protection IEC 529	IP 20
Overvoltage category	II
Degree of pollution IEC EN 60664-1:2004	1
Working position	any
Installation	on DIN rail
Connections	5 × RJ45 Power supply: screw terminals
Conductors cross-section	max. 2.5 mm <sup>2</sup>

### Communication

Standard	10/100base TX, IEEE 802.3
Number of ports	5 × TX

### Dimensions and weight

Dimensions	90 × 35 × 58 mm
Weight	75 g

### Power supply

Power supply voltage (SELV)	+24 V DC/40 mA
Allowed range	–15% ÷ +25% (20.4 ÷ 30 V DC)
Max. input power	1 W
Galvanic isolation	Yes, each port



SX-1162

### Order number

TXN 111 62 SX-1162, ETH switch, 5 × 10/100base TX, IEE802.3



## Ethernet switch 10/100 with ports for optical network

Type	DI	DO	AI	AO	Comm
<b>105FX</b>					4 × 10/100BaseTX RJ-45 1 × 100BaseFX (SC)
<b>306FX2</b>					4 × 10/100BaseTX RJ-45 2 × 100BaseFX (SC)

### Basic features

- 4 × UTP port 10/100BaseTX according IEEE 802.3. standard.
- 1 × 100BaseFX at type 105FX, optical network.
- 2 × 100BaseFX u modelu 306FX2, optická síť.
- Robust design in metallic box. Designed for extended range of operational temperatures.
- Supported functions.
  - Full/Half Duplex Operations
  - Auto Sensing Duplex,
  - Speed and MDIX
- Store and Forward technologies.

### Connection

- With RJ45 connector and standard ETH cables UTP CAT5.
- Optical fibre port connection with SC connector.
- Redundant inputs for power supply.
- Power supply 24 V DC input with screw terminals.
- Mechanic design for installation on DIN rail.

### Use

- Switches are designed to create LAN network, resp. to connect more devices compatible with 100base TX IEEE 802.3 and also for connection into optical fibre network for 100baseFX. Variants for SingleMode and MultiMode optical fibres are available.
- Switches are designed especially for connection of Foxtrout systems in redundant optical networks Ethernet.

Communication	105FX	306FX2
<b>TX ports (metallic)</b>	4 × 10/100BaseTX RJ-45, IEEE 802.3	4 × 10/100BaseTX RJ-45, IEEE 802.3
<b>FX ports (optical)</b>	1 × 100BaseFX (SC)	2 × 100BaseFX (SC)

Operating conditions	105FX	306FX2
<b>Operating temperature</b>	-40 ÷ +70 °C	-20 ÷ +70 °C
<b>Storage temperature</b>	-40 ÷ +85 °C	-40 ÷ +85 °C
<b>Working position</b>	Any	Any
<b>Installation</b>	on DIN rail	on DIN rail
<b>10BaseT connection</b>	>Cat3 cable	>Cat3 cable
<b>100BaseTX connection</b>	>CAT5 cable	>CAT5 cable
<b>100BaseFX connection</b>	MM 50 ÷ 62.5/125 µm SM 7 ÷ 10/125 µm	MM 50 ÷ 62.5/125 µm SM 7 ÷ 10/125 µm
<b>Power supply connection</b>	screw terminals	screw terminals
<b>Conductors cross-section</b>	max. 2.5 mm <sup>2</sup>	max. 2.5 mm <sup>2</sup>

Dimensions and weight	105FX	306FX2
<b>Dimensions</b>	97 × 38 × 120 mm	88 × 51 × 86 mm
<b>Weight</b>	270g	340g

Power supply	105FX	306FX2
<b>Power supply voltage (SELV)</b>	+24 V DC/270 mA	+24 V DC/250 mA
<b>Allowed range</b>	10 ÷ 30 V DC	10 ÷ 30 V DC
<b>Galvanic isolation</b>	Yes, each port	Yes, each port

Order number	
<b>105FX</b>	105FX ETH switch, 4 × 10/100base TX, IEE802.3, 1 × 100BaseFX, SC, unmanaged
<b>306FX2</b>	306FX2 ETH switch, 4 × 10/100base TX, IEE802.3, 2 × 100BaseFX, SC, unmanaged

www.tecomat.cz | Teco a.s., Havlíčkova 260, 280 02, Kolín 4, Czech Republic | teco@tecomat.cz | www.tecomat.com



105FX



306FX2

## GSM gateway for SMS communication

Type	DI	DO	AI	AO	Comm
<b>INSYS GSM Small</b>					RS-232/ GSM(SMS)

### Basic features

- GSM gateway – Dual Band – operate in networks 800 and 1800 MHz.
- Designed for monitoring and commanding Foxtrot systems via mobile phone.
- Module is ready for assembly on DIN rail with permanent connection with screw terminals.

### Connection

- Power supply is connected with screw terminals.
- Serial channel RS-232 is connected with 9 pole DSub connector at front side.
- SIM card is put in slot placed at bottom side.
- External antenna may be connected with FME connector both directly to module or with cable to optimal place, for example outside the installation cabinet.

### Connection example

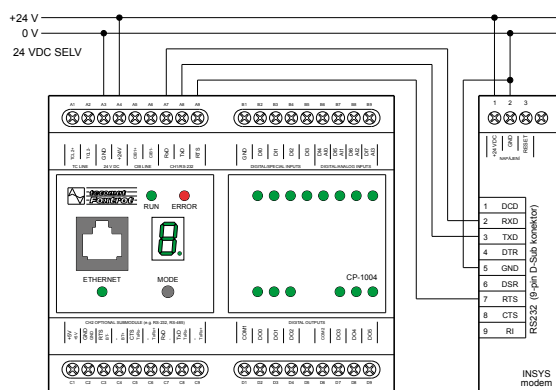

### Use

- Module is designed as bidirectional communication gateway into GSM network for central modules Foxtrot.
- Transmission of messages to Central Safety Guard.
- For Foxtrot system there is available library of functions for receiving and transmitting SMS messages and into program you may enter them in software Mosaic.
- In Mosaic software the module may be used as data modem controlled by AT commands.



INSYS GSM Small

### Communication

Connection to central module	1 × RS-232 DSub connector at front side
GSM network	Dual Band EGSM800, GSM1800

### Operating conditions

Operating temperature	0 ÷ +55 °C
Storage temperature	-30 ÷ +70 °C
Electric strength	according EN 60950
IP Degree of protection IEC 529	IP 20
Overvoltage category	III
Degree of pollution IEC EN 60664-1:2004	2
Working position	Any
Installation	on DIN rail
Connections	Power supply, screw terminals
Conductors cross-section	max. 2.5 mm <sup>2</sup>

### Dimensions and weight

Dimensions	120 × 23 × 75 mm
Weight	125 g

### Power supply

Power supply voltage (SELV)	12 ÷ +24 V DC/80 ÷ 160 mA
-----------------------------	---------------------------

### Order number

INSYS GSM Small	INSYS GSM Small, GSM gateway – band 900, 1800 Mhz (dual-band)
-----------------	---

## M-Bus communication module

Type	DI	DO	AI	AO	Comm
<b>SX-1181</b>			1		RS-232, M-Bus

### Basic features

- SX-1181 is module for connection of up to 64 devices equipped with interface M-Bus (IEC EN 1434) – usually heat measurement etc.
- Power supply RS-232 is 24 V DC/10 mA.
- Power supply of M-Bus part 24 V DC/30 to 150 mA is galvanic isolated with isolation voltage 3 kV. Consumption depends on number of connected devices.

### Connection

- Mechanic design suitable for DIN rail assembly.
- Modules are designed for connection to serial channel RS-232 on basic module.
- Interface M-Bus is taken out on screw terminals, see connection example.

### Use

- For installations where energy meters with M-Bus interface are becoming part of the project and for collecting and transmitting data over networks M-Bus and Ethernet/Internet.
- Connection of heat meters with integrated interface M-Bus according to EN 1434 (IEC EN 1434) standard.

### Communication

Connection to central module	RS-232, Tx,Rx
Installation bus/protocol	M-Bus
Transmission speed	Max 9.6 kBd
Transmitter:	
Output Voltage UMark	typ. 36 V (min.24 V max.40 V)
Output Voltage USpace	typ. 24 V (max. UMark –10 V)
Receiver:	
Data detection – sign	bus current < standby current +6 mA
Data detection – space	bus current > standby current +9 mA

### Operating conditions

Operating temperature	-20 ÷ +55 °C
Storage temperature	-30 ÷ +70 °C
Electric strength	according EN 60950
IP Degree of protection IEC 529	IP 10B
Overvoltage category	II
Degree of pollution IEC EN 60664-1:2004	1
Working position	any
Installation	on DIN rail
Connections	screw terminals
Conductors cross-section	max. 2.5 mm <sup>2</sup>

### Dimensions and weight

Dimensions	90 × 36 × 65 mm
Weight	75 g

### Power supply

Power supply voltage (SELV)	+24 V DC
Allowed range	18 ÷ 30 V DC
Max. input power	4 W
Galvanic isolation	Yes



SX-1181

### Order number

TXN 111 81	SX-1181, M-Bus – Communication module for connection of M-Bus stations.
------------	---

# MULTIFUNCTIONAL MEASUREMENT MODULE OF 3 PHASE POWER LINE

Type	DI	DO	AI	AO	Comm
<b>SMM-33</b>			3 × U; 3 × I (3 phase power line)		RS-485

## Basic features

- Module is designed for measuring and monitoring of basic values in 3 phase power line  $3 \times 230 V_{ef}$ .
- Measured values:
  - Phase voltage and current
  - Line voltage and current
  - Active and reactive power
  - Power factor
  - Total harmonic distortion (THD) of voltage and current.
  - Frequency
- Inputs are designed for direct connection of voltage  $3 \times 230 V_{ef}$  and separated current inputs up to  $5 A_{ef}$ .

## Connection example

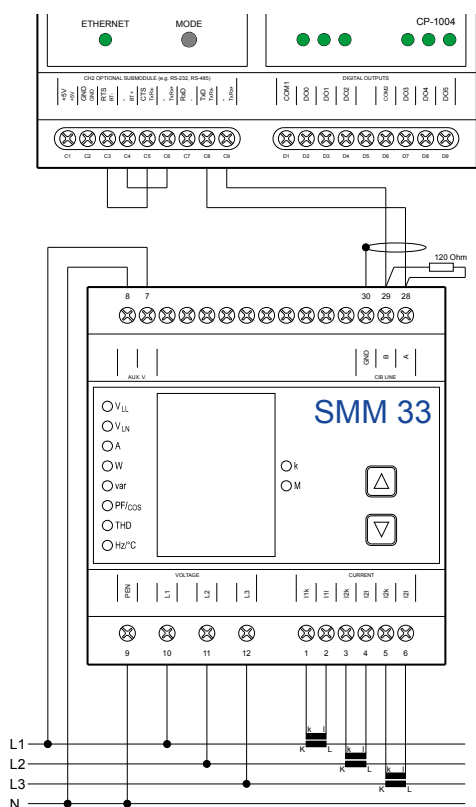

## Connection

- Module is powered from 230V AC.
- Voltage is connected via fuse directly to inputs L1, L2, L3.
- Signals from current transformers are connected to pair of I1 (l, k) I2 (l, k) a I3 (l, k) terminals.
- It is necessary to take care about the orientation of transformers and phase order.
- SMM-33 module is to be connected to the Foxtrot basic module by CH2 equipped with RS-485 interface submodule.

## Use

- For monitoring of 1 and 3 phase power supply network 230 V AC.
- Besides voltage and current you can get value of actual active and reactive power in all phases and this information can be used for automation of connected object. For example for monitoring 1/4 hour maximum.
- For permanent monitoring of power factor and harmonic distortion, whose change may indicate wrong connection of devices.
- In residential buildings measured data can be used for the consumption control to avoid exceeding of maximum current set by house main circuit breaker.

## Communication

<b>Serial channel</b>	RS-485, protocol MODBUS or KMB protocol
-----------------------	---

## Analog inputs

<b>Measured voltage</b>	$3 \times 5 - 500 V_{AC}$
<b>Voltage measurement accuracy</b>	$\pm 1\% \pm 1$ digit
<b>Connection</b>	star
<b>Allowed overload/top overload</b>	$2 \times / 4 \times < 1s$
<b>Frequency</b>	45 – 65 Hz
<b>Measured current</b>	$0.02 - 7 A_{AC}$
<b>Current measurement accuracy</b>	$\pm 1\% \pm 1$ digit
<b>Power consumption</b>	$< 0.25 VA$
<b>Galvanic isolation</b>	Yes
<b>Allowed overload</b>	$14 A_{AC}$
<b>Active power (<math>P_{nom} = 230 \times 5 W</math>)</b>	Range is limited by range of measured voltage and current
<b>Active power measurement accuracy</b>	$\pm 2\%, \pm 1$ digit
<b>Reactive power (<math>P_{nom} = 230 \times 5 VA</math>)</b>	Range is limited by range of measured voltage and current
<b>Reactive power measurement accuracy</b>	$\pm 2\%, \pm 1$ digit
<b>Power factor (accuracy)</b>	0.00 – 1.00 ( $\pm 2\%, \pm 1$ digit)
<b>THD (accuracy)</b>	Up to 25th harmonic order; 0 – 200%; ( $\pm 2\%, \pm 1$ digit)

## Dimensions and weight

<b>Dimensions</b>	$90 \times 53 \times 89 mm$
<b>Weight</b>	300 g

## Power supply

<b>Power supply voltage (SELV)</b>	230 V AC
<b>Allowed range</b>	$-15\% +25\% (20.4 \div 30 V DC)$
<b>Max. input power</b>	3 W
<b>Galvanic isolation</b>	Yes

## Operating conditions

<b>Operating temperature</b>	$-20 \div +55 ^\circ C$
<b>Storage temperature</b>	$-40 \div +85 ^\circ C$
<b>IP Degree of protection IEC 529</b>	IP 20
<b>Overvoltage category</b>	III
<b>Degree of pollution IEC EN 61010-1</b>	2
<b>Working position</b>	Vertical
<b>Installation</b>	on DIN rail
<b>Connection</b>	screw terminals
<b>Conductors cross-section</b>	max. $2.5 mm^2$

## Order number

<b>SMM-33</b>	SMM-33, multifunctional module to measure 3 phase network
---------------	---



SMM-33

## Related products



MR-0114 – communication submodule RS-485 into Foxtrot

# Displays

## Displays connected via Ethernet/LAN

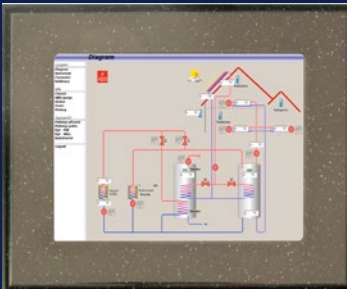

ID-18



ID-18 Design



ID-28

## Displays connected via system bus TCL2

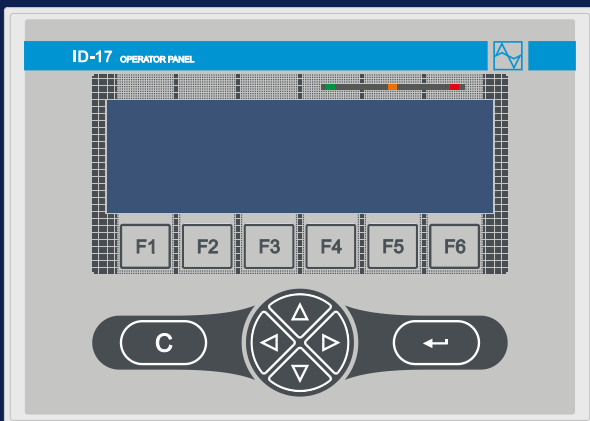

ID-17



ID-14

## Displays connected via serial channel

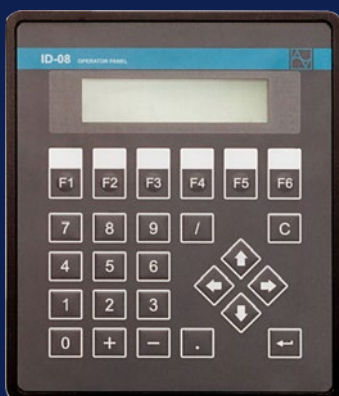

ID-08



ID-07



## Displays, operator panels

Type	DI	RO	AI	AO	Comm
<b>ID-18</b> (in to wall)					Ethernet
<b>ID-28</b> (in to panel)					Ethernet

### Basic features

- Graphic panel with touch screen
- Low power consumption, without cooling, without heating even in closed spaces, wide range of operation temperatures.
- Installed microbrowser, interprets directly built-in web pages of Foxtrot, TC700.
- **ID-18** is designed for installation in the wall, where is no access from other side. KO110/L installation box is the part of delivery.
- **ID-28** is designed for installation at the doors of control cabinets or in any place where it is the access from other side.
- Other features are the same for both panels.
- It is equipped with TFT display 5.7" with resolution 640×480 pixels (VGA).
- Front frame design – plastic with dimension 180×150 mm, white color. Other colors according to sampler after the order.

### Connection

- Can be connected directly to the Foxtrot or over the LAN by UTP/RJ45 cable
- Power supply 24 V DC, power consumption up to 5 W with full backlight.

### Use

- All places where we need graphics with high resolution, save space and low consumption.
- Designed especially for local displaying web pages stored in control systems Foxtrot, TC700, created in WebMaker.
- Designed for interiors as comfortable Room/House manager, both for administrative and residential buildings..

### Examples of screens created in WebMaker

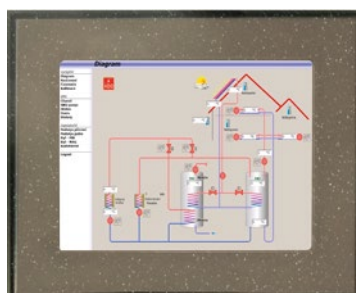

### Communication

System I/O bus	Ethernet 10/100baseTX, IEEE 802.3
Galvanic isolation Communication	Yes

### Operating conditions

Operating temperature	-20 ÷ +55 °C
Storage temperature	-30 ÷ +70 °C
Electric strength	according EN 60950
IP Degree of protection IEC 529	IP 10B
Overvoltage category	III
Degree of pollution IEC EN 60664-1:2004	2
Working position	any
Installation	Into installation box
Connection	Ethernet RJ45; Power supply with screw terminals
Conductors cross-section	max. 2.5 mm <sup>2</sup>

### Screen

Display type	Full color TFT LCD
Display size	5.7" (180×150 mm),
Resolution	VGA (640×480)
Keyboard	Touch screen

### Dimensions and weight

Dimensions	180×150×55 mm
Weight	1015 g

### Power supply

Power supply voltage (SELV)	+24 V DC/200 mA
Allowed range	-15% +25% (20.4 ÷ 30 V DC)
Max. input power	5 W
Galvanic isolation of power supply	No

### Order number

TXN 054 39	ID-18; 5.7" TFT 640×480; touch panel; 100/10 Ethernet; built-in into the wall
TXN 054 40	ID-28; 5.7" TFT 640×480; touch panel; 100/10 Ethernet; into electrical installation cabinet
TXN 054 42	D-18 Design; 5.7" TFT 640×480; touch panel; 100/10 Ethernet; built-in into the wall. It is necessary to complete with metallic front frame that has to be ordered separately according to RAL sampler.

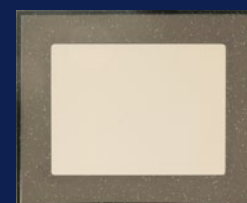

ID-18



ID-18

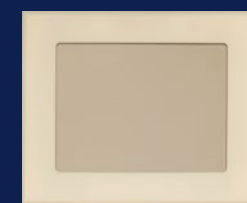

ID-28



ID-28

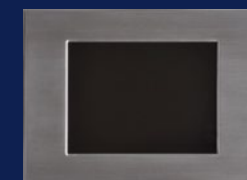
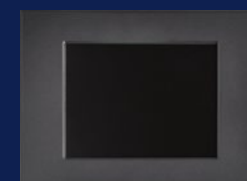

ID-18 Design

according to RAL sampler

## Graphic panel with keyboard

Typ	DI	RO	AI	AO	Comm
<b>ID-17</b>	4	2			TCL2

### Basic features

- Graphic operator panel used for programmable controllers Tecomat Foxtrot and Tecomat TC700.
- It is equipped with monochromatic (blue) backlit LCD with 240×64 pixels.
- Keyboard with 12 keys, 6 of them (F1 – F6) can be used as user defined keys.
- Equipped with 4 binary inputs 24 V DC – for example for external buttons.
- Equipped with 2 relay outputs (up to 230 V AC) – for example for siren.
- Internal memory for control files 2 MB.
- Support for multilanguage objects/texts – up to 15
- Available code pages/fonts
  - CP1250, Central European
  - CP1251, Cyrillic
  - CP1252, Western European
  - CP1253, Greek
  - User fonts – defined by the user – big digits, own symbols

### Connection

- It can be connected to central module by TCL2 bus up to 300 m via metallic cable.
- Using the fibre optic converter, it can be connected up to 1.7 km!
- Unique address on TCL2 bus can be set in the service mode using keyboard and display.
- It is possible to connect up to 4 graphical display ID-17 to the internal bus TCL2 that does not increase number of peripheral I/O modules.

### Use

- For operation of measurement and control devices, machines and technologies.
- The operator panel is used for entering commands and parameters, displaying a system status and user messages.
- Graphics is created with GPMaker – an integrated part of Mosaic
- Available objects:
  - Static/dynamic text
  - Static/dynamic/animated image
  - Container – multipage image
  - Display – value viewing
  - Password
- Managers:
  - Images
  - Fonts
- Multi-language texts



ID-17

### Connection example

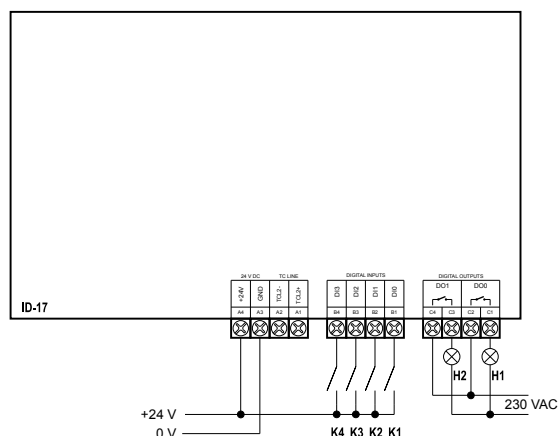

### Relay outputs

No. of outputs	2
Galvanic isolation	Yes
Type of contact/type of output	Electromechanical relay, non-protected output
Switched voltage	min. 5 V; max. 250 V
Switched current	min. 100 mA; max. 3 A
Short-term output overload	max. 4 A
Current through common wire	max. 10 A
Time of close/open the contact	typ. 10 ms/4 ms

### Digital inputs

No. of inputs	4
Common wire	minus (GND)
Galvanic isolation	No
Input voltage for log. 0 ( $U_i$ )	0 V DC; (-5 ÷ +5 V DC)
Input voltage for log. 1 ( $U_i$ )	+24 V DC; (+15 ÷ +30 V DC)
Input current for log. 1 ( $I_i$ )	typ. 5 mA
Delay 0 → 1/1 → 0:	5 ms/5 ms (DI4–DI7)

### Display

Display size	127×33 mm
Resolution, color	240×64, white on blue background
Keyboard	Membrane
Keys number	12×: 4× cursor, 1× Clear, 1× Enter, 6× for user defined functions

### Operating conditions

Operating temperature	-20 ÷ +55 °C
Storage temperature	-30 ÷ +70 °C
Electric strength	according EN 60950
IP Degree of protection IEC 529	IP 10B
Overvoltage category	III
Degree of pollution IEC EN 60664-1:2004	2
Working position	any
Installation	In the control panel
Connection	Screw terminals
Conductors cross-section	max. 2.5 mm <sup>2</sup>

### Dimensions and weight

Dimensions	143×202×36 mm
Weight	1100 g

### Power supply

Power supply voltage (SELV)	+24 V DC/70 mA
Allowed range	-15% ÷ +25% (20.4 ÷ 30 V DC)
Max. input power	2 W
Galvanic isolation Power supply	No

### Order number

TXN 054 37	ID-17, Graphic operator panel, monochrom LCD, 240×64 px, 12 keys
------------	--

## Alphanumeric panel with LCD and keyboard

Type	DI	DO	AI	AO	Comm
<b>ID-14</b>					TCL2

### Basic features

- Alphanumeric operator panel for programmable controllers Tecomat Foxtrot and Tecomat TC700.
- It has monochromatic backlit LCD with 4×20 characters.
- Keyboard with 25 keys, 6 of them (F1 – F6) can be used as user defined keys.
- There can be up to 4 panels ID-14 connected on the one TCL2 bus.
- Panel enables to display characters in following code pages: CP852, CP1250, CP1251 (Cyrillic), CP1252.
- Programming is done directly in Mosaic in Panel Maker.

### Connection

- It can be connected to central module by TCL2 bus up to 300 m via metallic cable.
- Using the fibre optic convertor, it can be connected up to 1.7 km!
- Panel ID-14 can be mechanically fixed with Foxtrot central module in one ensemble and can be placed in the door of control panel.
- The panel is connected to Foxtrot PLC directly through screw-type terminals and to the TC700 series PLC via terminal board KB-0220.
- Unique address on TCL2 bus must be set in the service mode using keyboard and display.

### Use

- The operator panel is used for entering commands and parameters, displaying a system status and textual user messages.



ID-14



ID-14 + CP-1004

### Connection example

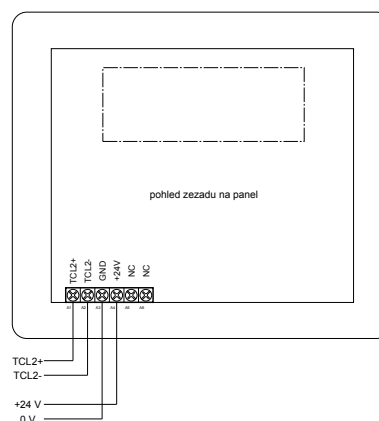
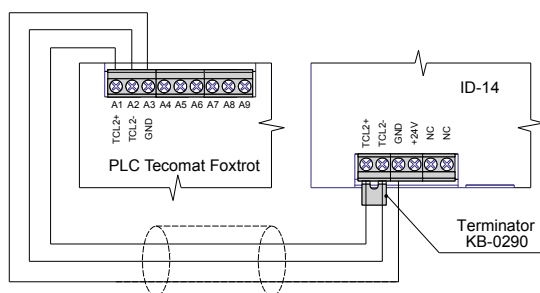

### Communication

System I/O bus	1 × TCL2 (RS-485, 345 kbps) up to 300 m
Galvanic isolation of communication	No

### Display and Keyboard

Character size	3.5 mm
No. of characters	4 × 20 characters
Keyboard	Membrane
Keys	25 keys 10 × numeric 4 × cursor 6 × functional 5 × other

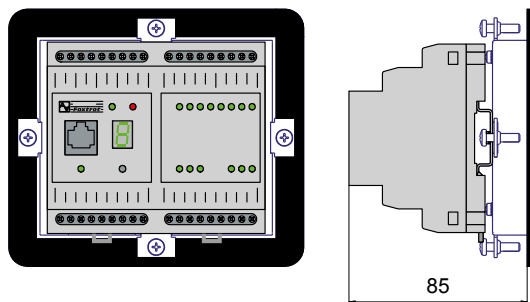

### Operating conditions

Operating temperature	-20 ÷ +55 °C
Storage temperature	-20 ÷ +60 °C
IP Degree of protection IEC 529	IP 54 – front panel IP 20 – whole product
Overvoltage category	II
Degree of pollution IEC EN 60664-1:2004	2
Working position	any
Installation	In control panel doors On DIN rail with SM-9024
Connection	Screw terminals
Conductors cross-section	max. 2.5 mm <sup>2</sup>

### Dimensions and weight

Dimensions	123 × 141 × 25 mm
Weight	560 g

### Power supply

Power supply voltage (SELV)	+24 V DC/125 mA
Allowed range	-15% ÷ +25% (20.4 ÷ 30 V DC)
Max. input power	3 W
Galvanic isolation of power supply	No

### Order number

TXN 054 33	ID-14 display 4×20 characters, 25 keys, set for installation in the control panel doors
TXF 790 25	SM-9025 set for DIN rail installation on the ID-14 panel (for compact installation together with CP-100×)
TXF 790 24	SM-9024 set for ID-14 installation on the DIN rail (for installation inside the control panel)
TXN 102 20	KB-0220, terminal board for TCL2 bus connection to TC700

## Alphanumeric panel with keyboard

Type	DI	RO	AI	AO	Comm
<b>ID-07</b>					RS-232/RS-485
<b>ID-08</b>					RS-232/RS-485

### Basic features

- Alphanumeric operator panel for programmable controllers Tecomat Foxtrot and Tecomat TC700.
- ID-07 is smaller and is equipped with monochromatic backlit LCD with 4×20 characters with characters height 8 mm. Keyboard contains 8 buttons.
- ID-08 has also backlit monochromatic display with 2×20 characters, but character height is 12 mm. Keyboard has 26 buttons of which 6 buttons (F1–F6) is dedicated for user defined functions.
- Panel enables to display characters in following code pages: CP852, CP1250, CP1251 (Cyrillic), CP1252 and Kamenicky.
- Programming is done directly in Mosaic in Panel Maker.

### Connection

- Connection via serial channel of programmable controller. Interface is optional: RS-232, RS-422 or RS-485.

### Use

- Panel for entering commands and system status indication and user text messages.



ID-07

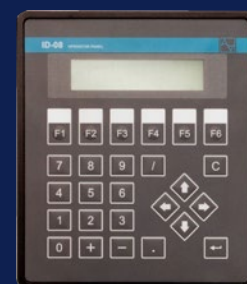

ID-08

### Operating conditions

Operating temperature	0 .. +50 °C
Storage temperature	–20 .. +60 °C
Electric strength	according EN 60664-1:2004
IP Degree of protection(IEC 529)	IP54 front panel, IP20 whole device
Overvoltage category	II
Degree of pollution according IEC EN60664-1:2008	2
Working position	vertical
Installation	into the panel
Connection of power supply and communication	Screw terminals max. 4 mm <sup>2</sup>

### Power supply

Power Voltage	24 V DC +– 20%, 24V AC –+20%, 50–60Hz
---------------	--

### Dimensions and weight ID-07

Dimensions	141 × 123 × 42 mm
Weight	400 g

### Dimensions and weight ID-08

Dimensions	177 × 205 × 42 mm
Weight	750 g

### Order number

TXN 054 25.11	ID-07 panel LCD 2×16 characters, 8 buttons, optional interface
TXN 054 26.11	ID-08 panel LCD 2×16 characters, 26 buttons, optional interface
TXN 054 26.12	ID-08 panel LCD 4×20 characters, 26 buttons, optional interface

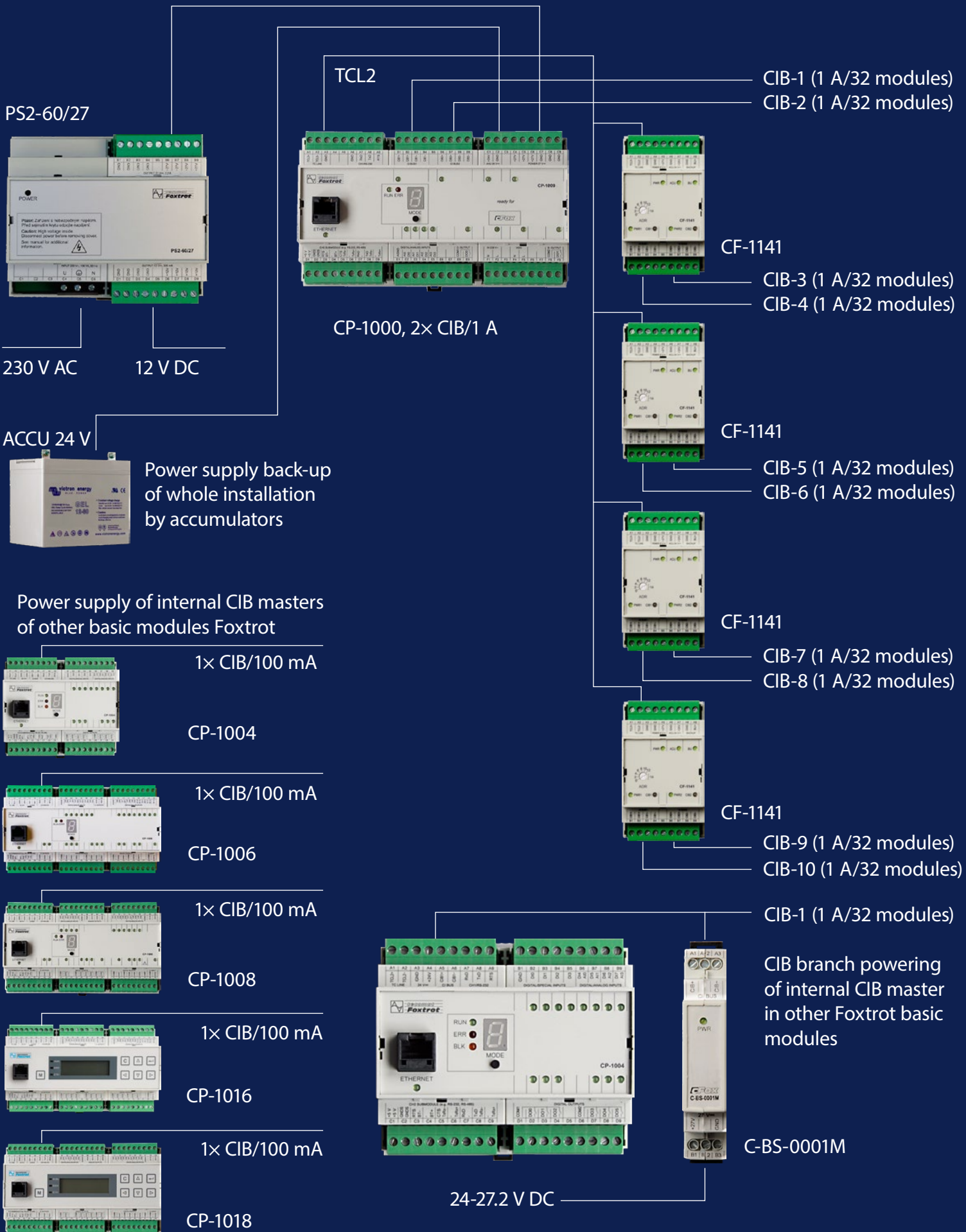



CIB – bus with free topology, max. 400 m

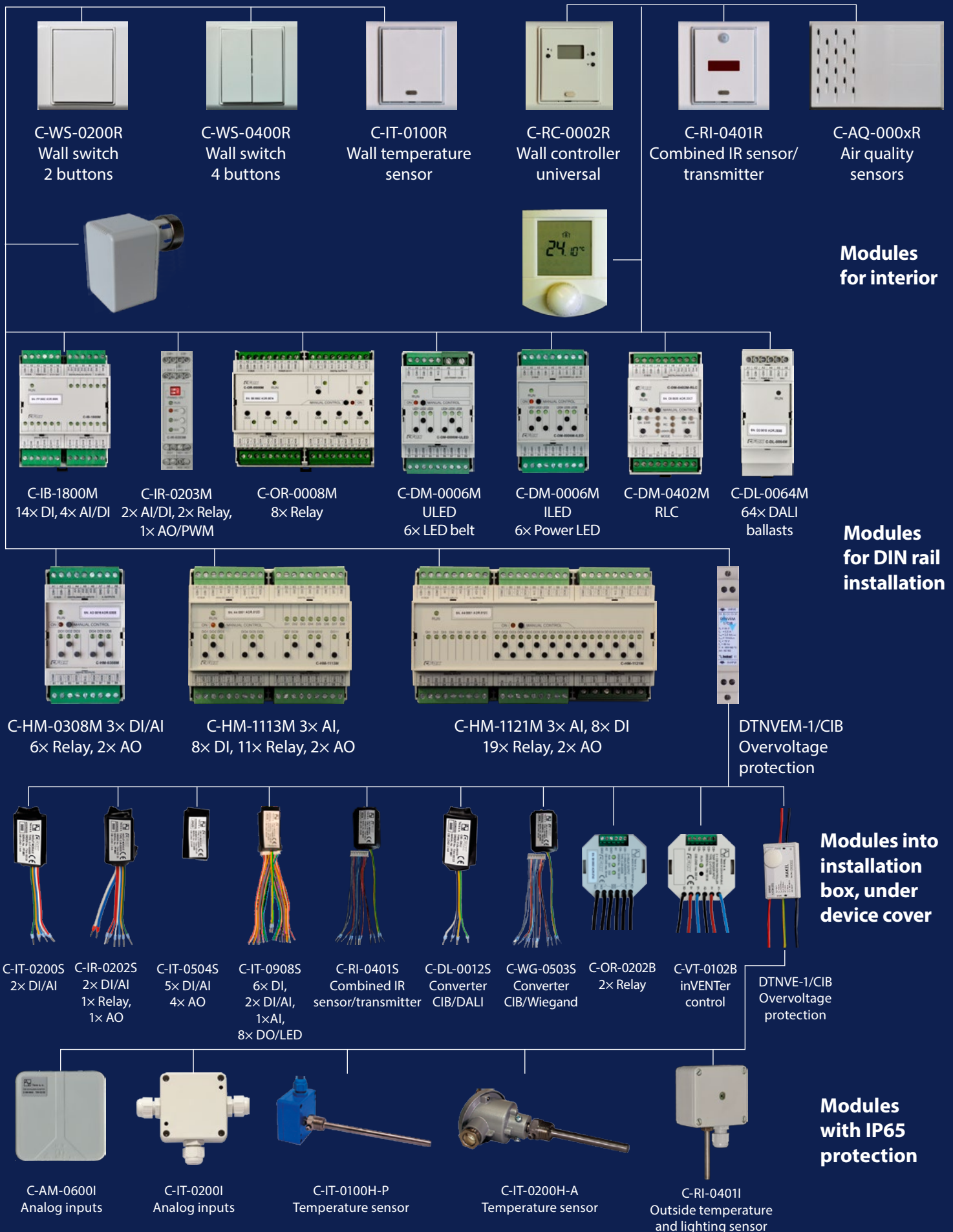

## External CIB bus master, Separation module CIB bus

Type	DI	RO	AI	AO	Comm
<b>CF-1141</b>					TCL2, 2×CIB
<b>C-BS-0001M</b>					

### Basic features CF-1141

- Module is designed to expand the number of CIB bus branches connected to one Foxtrot basic module.
- Contains 2×CIB bus master and enables to expand number of connected modules with next 2×32 = 64 modules.
- Module provides power supply of both bus branches via built-in separators of connected power supply 24/27 V DC.
- Foxtrot basic module can be expanded with up to 4 external CF-1141, what means expansion up to 4×2×32 = 288 CIB modules.
- Status operation/error is indicated on front panel.
- Module can be connected with 2×12 V accumulators in serial connection as back-up power supply for both CIB buses and for one another load e.g. for central module.
- Capacity of accumulator has to be chosen according to demand time of back-up, module can charge accumulators with continuous current max. 3 A.

### Connection

- Connection with central module Foxtrot should be via cable into TCL2 bus, maximum length 400 m. The unique address on TLC2 bus is set manually with rotary switch at front panel.
- Modules CF-1141 are not counted into maximal limit of 10 modules at TCL2 bus.

### Connection example CF-1141

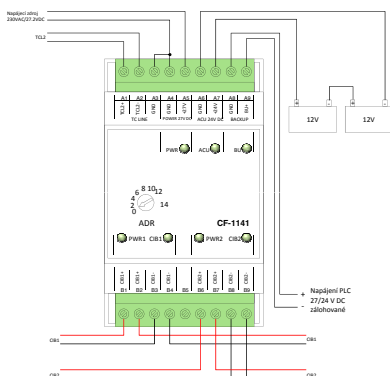

Communication	C-BS-0001M	CF-1141
TCL2	–	1×; max. 4 modules at TCL2
CIB	1× passive separator of power supply	2× master with integrated separator

### Operating conditions

Operating temperature	–0 ÷ +70 °C
Storage temperature	–25 ÷ +85 °C
Electric strength	according EN 61131
IP Degree of protection IEC 529	IP 10B
Overvoltage category	II
Degree of pollution IEC EN60664-1:2008	1
Working position	vertical
Installation	on DIN rail
Connections	CF-1141 screw-type removable connector, C-BS-0001M Screw-type terminals

### Order number

TXN 111 41	CF-1141; CIB 2x master CIB powered, totally for 64 slaves
TXN 133 55	C-BS-0001M, CIB bus separator, 1A

### Basic features C-BS-0001M

- Module is designed for separation of CIB bus from power supply. Its impedance allows to modulate CIB communication on the power supply voltage.
- Module contains separation of one CIB bus branch.
- Power status is indicated at front panel.

### Connection

- Power supply 24 or 27.2 V DC is connected to the module by 2 screw type terminals.
- Terminals marked CIB+ and CIB– has to be connected to CIB bus terminals of central module Foxtrot CP-10xx.

### Use

- Module is designed especially for basic modules Foxtrot types CP-10xx with one internal CIB master without internal separator.
- Module can be used for separation of complementary power supply, if there is on CIB bus higher load (>1 A) then is allowed by separator integrated in master of basic module CP-1000 or external master CF-1141.

### Connection example C-BS-0001M

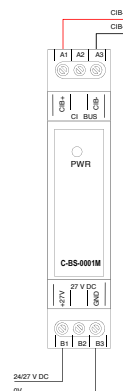

### Dimensions and weight CF-1141

Dimensions	52×100×60 mm (3M)
Weight	120 g

### Dimensions and weight C-BS-0001M

Dimensions	18×100×56 mm (1M)
Weight	75 g

### Power supply CF-1141

Input voltage – range	24 ÷ 27.2 V DC
Output voltage for CIB	2×24 ÷ 27 V DC, 1 A
Output back-up voltage	1×24 V DC e.g. for the basic module
Connected accumulators	2×12 V in serial
Maximal continuous charging current	3 A. Do not connect uncharged accumulators!
Max. input power	85 W
Internal protection	Yes

### Power supply C-BS-0001M

Input voltage – range	24 ÷ 27.2 V DC
Output voltage CIB	1×24 ÷ 27 V DC, 1 A



CF-1141



C-BS-0001M

## Overvoltage protection for CIB bus

Typ	DI	DO	AI	AO	Comm
<b>DTNVEM-1/CIB</b>					
<b>DTNVE-1/CIB</b>					

### Basic features

- Overvoltage protection device is designed for protection of CIB bus against flash current and overvoltage.
- Combined overvoltage protection of power supply and data communication – corresponds to the CIB.
- It contains the base and the exchange module. The base is permanently connected with CIB installation. Manipulation with exchange module does not interrupt the bus and its function.

### Connection

- Module is connected in serial into each protected CIB bus branch.
- The necessity of protection has to be evaluated for each CIB branch separately.
- In project it is necessary to calculate the voltage drops on overvoltage protections, which depend on consumption of modules behind the overvoltage protection.

### Use

- To protect CIB bus and devices connected on CIB bus against the flash current and overvoltage.
- Place as close to supposed source of overvoltage as possible.
- It is recommended to place the protection at input from outdoor to indoor of the building and in place of parallel way of CIB with lightning rod.

### Connection example

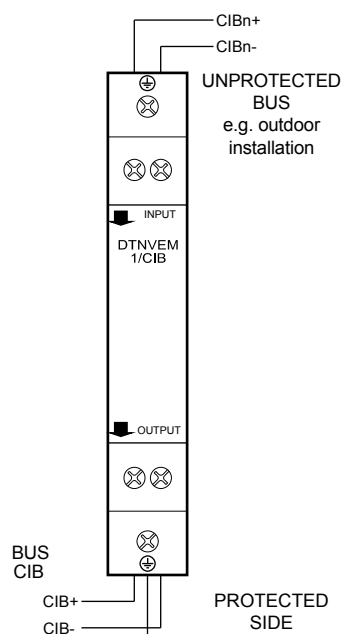

### Operating conditions

Operating temperature	-40 ÷ +80 °C
Storage temperature	-40 ÷ +80 °C
IP Degree of protection IEC 529	IP 20
Degree of pollution IEC EN 60664-1:2004	2
Working position	any
Installation	on DIN rail
Connections	screw terminal
Conductors cross-section	max. 2.5 mm <sup>2</sup>

### Order number

DTNVEM 1/CIB	DTNVEM 1/CIB Overvoltage protection for CIB bus
DTNVE 1/CIB	DTNVE 1/CIB Overvoltage protection for CIB bus

### Technical features

No. of protected buses	1
Category of protection device according to IEC EN 61643-21	A2, B2, C2, C3, D1
Nominal operation voltage	24 V DC
Maximal operation voltage	36 V DC
Maximal permanent current	0.5 A
Impulse current 10/350	2.5 kA/cable
Nominal discharge current 8/20	1 kA/cable
Maximal discharge current 8/20	10 kA/cable
Voltage protection level	<75 V (between A/PE, B/PE, A/B)
Response time	<30 ns

### Dimensions and weight DTNVEM 1/CIB

Dimensions	90 × 13 × 65 mm
Weight	75 g

### Dimensions and weight DTNVE 1/CIB

Dimensions	45 × 30 × 7 mm
Weight	35 g



DTNVEM-1/CIB



DTNVE-1/CIB

# CIB – Module of digital and combined inputs on DIN rail

Type	DI	RO	AI	AO	Comm
<b>C-IB-1800M</b>	14x DI		4x AI/DI		CIB

## Basic feature

- Module is designated for direct connection of voltage-free contacts and resistance sensors (RTD) on CIB bus.
- Inputs AI1/DI1 to AI4/DI4 may be set as:
  - analog
  - digital
  - security system inputs (single or double balanced)
  - counter for reading of pulses from energy meters (S0)
- Inputs DI5 to DI18 may be set as:
  - digital
  - Security system inputs (single or double balanced).
- Module firmware linearizes characteristic of selected types of RTD, optimizes accuracy of measurement and recalculates resistance to temperature in Celsius degrees, which is transferred via CIB bus into central module.

- Digital inputs may operate in normal mode with signalling 0/1 (on/off) or in balance mode with signalling of:
  - interrupted wire
  - On 3. Off 4. Sabotage (tamper)
- Status error/run is indicated by LED on module (RUN).

## Connection

- Module is connected to CIB bus via screw terminals.
- Contact inputs and resistance sensors are connected via screw terminals.

## Use

- The module is universal input module and is designated for connection of any contact and resistance inputs combination.
- Module may be used as integrated reader of up to 4 temperatures.
- Module may be used for connection of security detectors via balanced loops.
- For connection of PIR (motion detectors) and other security detectors, the module is equipped by power supply 12V DC derived from CIB bus.



C-IB-1800M

## Connection example

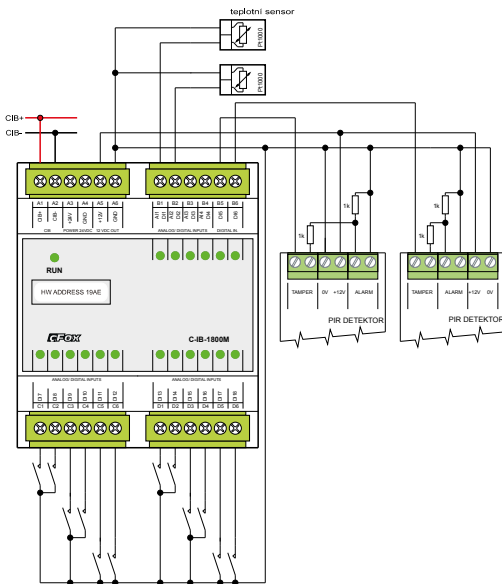

## Digital inputs

Number of digital inputs	14x DI (DI5-DI18)
Number of inputs with security system function	14x DI (DI5-DI18)
Galvanic isolation	No

## Universal inputs (analog/digital)

Number of universal inputs	4x AI/DI (AI1/DI1-AI4/DI4)
Number of counter inputs	4x (AI1/DI1-AI4/DI4)
Counter range	16 bit
Galvanic separation	No

## Operating conditions

Operating temperature	0 .. +70 °C
Storage temperature	-25 .. +85 °C
Electrical strength	according EN 60730
IP Degree of protection IEC 529	IP10B
Overvoltage category	II
Degree of pollution according EN60664-1:2008	1
Operating position	Vertical
Installation	On DIN rail
Connection of inputs and CIB bus	4x screw terminals, wire diameter max. 2,5 mm <sup>2</sup>

## Sensor type

Sensor type	Range	Basic accuracy
Potential-free contact	0/1	0 if > 1.5 kΩ 1 if < 0.5 kΩ
Balanced input	Interrupted wire /0/1/tamper	for 2x 1k bal. resistance
Pt1000	-90 .. 320°C	0,5%
Ni1000	-60 .. 200°C	0,5%
NTC 12k	-40 .. 125°C	0,5%
KTY81-121	-55 .. 125°C	0,5%
Resistance	0-160 kΩ	0,5%

## Dimensions and weight

Dimensions	70 x 93 x 59 mm
Weight	155 g

## Power supply

Power supply and communication	24 V (27V) from CIB bus
Nominal/max. load	50 mA/190 mA
Typical/Max. input power	1.2 W/3.8W
Internal protection	Yes, current circuit board reversible

## Order number

TXN 133 06	C-IB-1800M, CIB, 14DI, 4DI/AI, 4M
------------	-----------------------------------

# CIB – Module of combined inputs/outputs on DIN rail

Type	DI	RO	AI	AO	Comm
<b>C-IR-0203M</b>	2x DI/AI	2x RO		1x AO/PWM	CIB

## Basic features

- Module is an actuator on CIB bus with two independent relays 16A with NO/NC contacts.
- Each relay is independently addressed and controlled. Status of each relay is signalled at front panel.
- Module may be switched into manual mode by MC button. Then, outputs are controlled independently manually by buttons DO1 and DO2.
- Module is an actuator with one analog output 0-10V.
- Analog output may be switched by button at front panel to PWM mode (pulse width modulation). The amplitude and frequency of switching may be set in the program.
- Module is also a sensor on CIB bus and has two universal inputs.

- Each input may be set as digital for reading voltage-free contact or as balanced input for security sensors.
- Each input may be set as analog for resistance sensors metering, e.g. temperature.
- Module firmware linearizes characteristics of selected types of resistance sensors, optimizes accuracy of metering and recalculates the resistance to temperature in Celsius degrees, which is transferred via CIB to central module.
- Status is indicated by LED on module (RUN).



C-IR-0203R

## Connection example

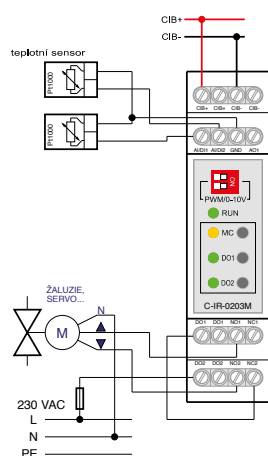

## Connection

- Inputs, outputs and CIB bus are connected via screw terminals.

## Use

- Module is universal and is designated for connection of various types and combinations of inputs and loads.
- By relay contacts features, the module is designated for switching of power loads, where we may expect transients with high current surge - up to 80A.
- Module is by its PWM output designated for control of revolutions of modern circulation pumps.

## Relay outputs

<b>Number of outputs</b>	2x NO/NC 16 A/AC1
<b>Galvanic isolation</b>	yes (even outputs each other)
<b>Switching voltage</b>	min. 5 V DC; max. 300 V AC/DC
<b>Switching power</b>	4000 VA/AC1, 384 W/DC
<b>Switching current</b>	max.16 A (NO) max.10 A (NC), min. 100 mA
<b>Peak current</b>	80 A / <20ms (switching contact)
<b>Time of switching on/off</b>	typ. 15 ms/ 5 ms
<b>Frequency of switching without load</b>	max. 1200 min <sup>-1</sup>
<b>Frequency of switching with load</b>	max. 6 min <sup>-1</sup>
<b>Mechanical life cycle</b>	2x10 <sup>7</sup>
<b>Electrical life cycle</b>	0,5x10 <sup>5</sup>
<b>Protection against short circuit</b>	No
<b>Inductive load treatment</b>	Outside. (RC element, varistor, diode)
<b>Isolation voltage between contacts each other/groups/ outputs and CIB bus</b>	1000V AC/ 4000V AC/ 4000V AC

## Operating conditions

<b>Operating temperature</b>	-10 .. +70 °C
<b>Storage temperature</b>	-25 .. +85 °C
<b>Electric strength</b>	according EN 60730
<b>Class of electric device protection according EN 61140:2003</b>	I
<b>IP Degree of protection IEC 529</b>	IP10B
<b>Overvoltage category</b>	II
<b>Degree of pollution according EN60664-1:2008</b>	1
<b>Operating position</b>	Vertical
<b>Installation</b>	On DIN rail
<b>Connection input, output, CIB</b>	Terminals, wire diameter max. 4mm <sup>2</sup> .

## Order number

TXN 133 59 C-IR-0203M, CIB, 2DI/AI, 2RO NO/NC contacts 230 V AC, 1AO/PWM

## Universal inputs

<b>Number of universal inputs</b>	2x DI/AI (DI/AI1, DI/AI2)
<b>Galvanic isolation of CIB bus</b>	No

## Measured ranges

Sensor type	Range	Basic accuracy
Voltage-free contact	0/1	0 if >1.5 kΩ 1 if <0.5 kΩ
Balanced input (security system)	Interrupted wire /0/1/tamper	for 2x 1k1 balanced resistance
Pt1000	-90 .. 320°C	0,5%
Ni1000	-60 .. 200°C	0,5%
NTC 12 k	-40 .. 125°C	0,5%
KTZ81-121	-55 .. 125°C	0,5%
Resistance	0-160 kΩ	0,5%

## Analog outputs

<b>Number of outputs</b>	1x
<b>Galvanic isolation</b>	No
<b>Output mode</b>	Analog PWM
<b>Nominal input voltage/amplitude</b>	10 V 10-24 V
<b>Frequency of switching</b>	100-2 000 Hz
<b>Adjustable range of outputs</b>	0..130% U <sub>n</sub> 0..100%
<b>Min. resolution/load resistance</b>	Min. 1% / > 1kΩ
<b>Output current/load capacity</b>	Max. 3 mA/ Max. 50 nF

## Dimensions and weight

<b>Dimensions</b>	105 x 90 x 22 mm
<b>Weight</b>	93 g

## Power supply

<b>Power supply and communication</b>	24 V (27 V) from CIB bus
<b>Nominal/max. load</b>	30 mA/60 mA
<b>Typ./Max. input power</b>	0.8 W/1.5 W
<b>Internal protection</b>	No



Type	DI	DO	AI	AO	Comm
<b>C-OR-0008M</b>		8x RO			CIB

## Basic features

- Module is an actuator with 8 independent relays 16 A each with both NO and NC contacts.
- Each relay has accessible all 3 contacts, they are galvanic isolated and can be connected on different potential levels.
- It is designed for switching of 8 independent devices/loads.
- Each relay is independently addressed and controlled.
- Module can be switched by button to manual mode, where each relay can be controlled manually by appropriate button.
- Status is indicated by LED on module.

## Connection

- Module is connected on two-wire bus CIB, that is responsible for communication and supplying of the module.
- To prevent the consumption from the CIB bus the C-OR-0008M module can be powered directly from an external source of 24 VDC
- Module is designed for DIN rail installation.

- Relay outputs are available on removable screw terminals.
- CIB bus is available on screw terminals.

## Use

- Module is designed for switching independent loads and devices by relay contacts.
- By suitable interconnection of output contacts the module can be used to control up to four 230 V drives - such as blinds or shutters with electric blocking of the concurrent connections of voltage on both control winding.
- With suitable connection of independent contacts the module can be used for control up to 4 DC drives with reversing.
- During planning the current of contacts and their protection with various types of loads should be rated.



C-OR-0008M

## Connection example

Connection of motor 230 V AC and 6 bulbs (general load).

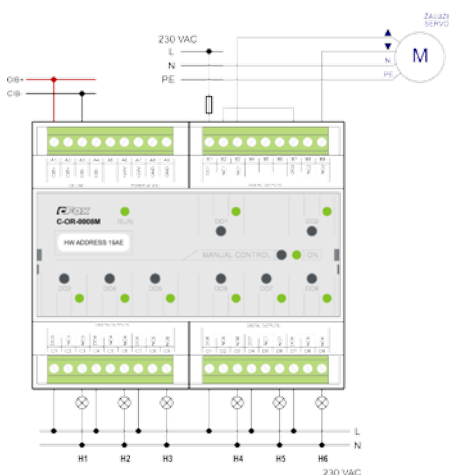

## Relay outputs

No. of outputs	8 x NO/NC contact
Galvanic isolation	Yes (even outputs each other)
Switching voltage	min. 5 V DC; max. 300 V AC
Switching power	4000 VA/AC1, 384 W/DC
Switching current	max. 16 A, min. 100 mA,
Inrush current	80 A/<20 ms (NO contact)
Time to switch on/off	typ. 15 ms/5 ms
Mechanical life	2 x 10 <sup>7</sup> switching
Electrical life	5 x 10 <sup>4</sup> (1 x 10 <sup>4</sup> at 80 A peak)

## Operating conditions

Operating temperature	-10 .. +55 °C
Storage temperature	-25 .. +70 °C
Electric strength	according EN 60730
IP Degree of protection(IEC 529)	IP 10B
Overvoltage category	II
Degree of pollution according IEC EN60664-1:2004	1
Working position	vertical
Installation	on DIN rail
Connections CIB	Screw terminals max. 4 mm <sup>2</sup>
Conductors cross-section relay outputs	Screw terminals max. 4 mm <sup>2</sup>

## Relay outputs

Short-circuit protection	No
Spike suppressor of inductive load	External. (RC, varistor, diode)
Insulation voltage between outputs and internal circuits and between DO1 and DO2	4000 V AC
Insulation voltage among DO2-DO4-DO5 and among DO6-DO7-DO8	1000 V AC

## Dimensions and weight

Dimensions	105 x 90 x 58 mm
Weight	310 g

## Power supply

Power supply and communication	24 V (27 V) from the CIB
Power supply from external power supply	24 V DC
Nominal/current consumption	160 mA (switched all relays)
Typical/consumption	3.4 W
Internal protection	No

## Order number

TXN 133 03 C-OR-0008M, CIB, 8x RO, NO/NC contacts, 230 V/16 A

Type	DI	RO	AI	AO	Comm
<b>C-HM-0308M</b>	see AI	6	3 AI/DI	2	CIB
<b>C-HM-1113M</b>	8	11	3	2	CIB
<b>C-HM-1121M</b>	8	19	3	2	CIB



C-HM-0308M



C-HM-1113M



C-HM-1121M

## Basic features

- Modules on DIN rail with combination of analog and digital inputs and outputs.
- Each module has on CIB bus only one address. That means on each CIB bus branch we may connect up to  $32 \times 32 = 1024$  analog and digital inputs and outputs in combination.
- 3 analog inputs for Resistance Temperature Detectors (RTD) and 2 analog outputs 0–10 V are designed for 1–2 regulation loop, e.g. heating, air-conditioning or for general use.
- Analog inputs of C-HM-0308M module may be configured for high resistance measurement, e.g. condensation sensor or as voltage free contact digital inputs.
- Modules C-HM-1113M and C-HM-1121M are equipped with 8 independent inputs for voltage free contacts.
- C-HM-0308M contains two galvanic insulated groups with 3 relays. Each group may be used independently for switching 24 V DC or 230 V AC.
- C-HM-1113M contains 4 galvanic insulated groups of relays for 3 A and 1 power relay for 16 A with separate NO contact. Each group may be used independently for switching 24 V DC or 230 V AC in different phases.
- C-HM-1121M contains 6 galvanic insulated groups of relays with normally open (NO) contacts and with common wire for 3A load and 3 independent relays for 16 A each with NO contacts available on the terminal. Each group can be used independently for switching 24 V DC or 230 V AC in different phases.
- Power relays for 16 A have contacts with combination of wolfram/AgSnO<sub>2</sub> for reliable switching of high loads.
- Each relay is separately addressed and controlled from program.

- After push button MANUAL CONTROL we may each relay control by appropriate button.
- Status of digital inputs, relay outputs, mode MANUAL CONTROL RUN are indicated by LEDs at front side of module.

## Connection

- Modules C-HM-0308M, C-HM-1113M, C-HM-1122M are connected at two-wire bus CIB, providing power supply and communication. HW address (4 hexadecimal digits) is shown at front panel.
- Modules C-HM-0308M, C-HM-1113M are powered from CIB bus, module C-HM-1121M is powered from power supply 230 V AC.
- Modules are connected with removable connectors and power connectors of C-HM-1121M module via fixed screw type terminal.

## Use

- Modules are used for large installations centralised into installation cabinet. Typically for one hotel room, one room or floor of residential house.
- Switching of R, L or C loads, independent outputs are used for switching of power loads, especially inductive or capacity loads.
- Control of circuits in rooms: sockets circuits, lighting, jalousies, heating and air-conditioning.
- Regulation of solar and combined systems.
- Module C-HM-0308M is suitable for input/output module for regulation nodes – regulation of heating circuits, FanCoil control, air heating, ventilation, air quality, recuperation, etc.

## Communication

Installation bus CIB

## Connection example

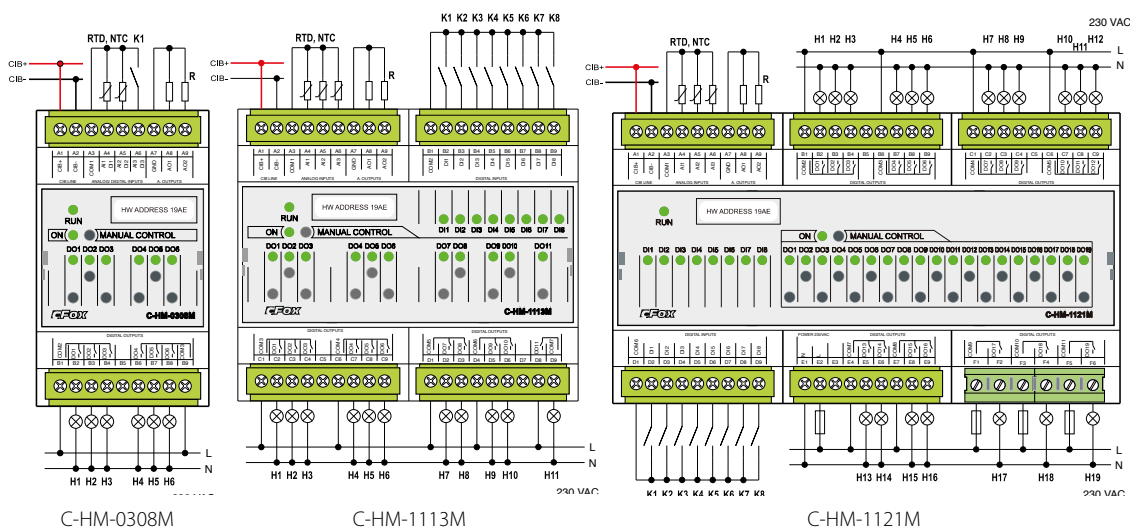

Analog outputs	C-HM-0308M	C-HM-1113M	C-HM-1121M
No. of outputs	2	2	2
Common wire	Minus (GND)	Minus (GND)	Minus (GND)
Galvanic isolation	No	No	No
Resolution	8 bit	8 bit	8 bit
Output range	0 ÷ 10V, 1 ÷ 10V	0 ÷ 10V, 1 ÷ 10V	0 ÷ 10V, 1 ÷ 10V

Analog inputs	C-HM-0308M	C-HM-1113M	C-HM-1121M
No. of inputs	3	3	3
Common wire	Plus	Plus	Plus
Galvanic isolation	no	no	no
Resolution	12 bit	12 bit	12 bit
Measurement ranges			
RTD	Pt1000, Ni1000	Pt1000, Ni1000	Pt1000, Ni1000
NTC (termistor)	12 k $\Omega$	12 k $\Omega$	12 k $\Omega$
Resistive – sensor of condensation	OV 600 k, OV 6M $\Omega$	OV 600 k, OV 6M $\Omega$	OV 600 k, OV 6M $\Omega$
Potential free contact	Yes, on each contact	–	–
Napětové rozsahy	50 mV, 100 mV, 1 V, 2 V	50 mV, 100 mV, 1 V, 2 V	50 mV, 100 mV, 1 V, 2 V

Digital inputs	C-HM-0308M	C-HM-1113M	C-HM-1121M
Input type	3 × potential free contact See Analog inputs	8 × potential free contact	8 × potential free contact

Relay outputs	C-HM-0308M	C-HM-1113M	C-HM-1121M
No. of outputs/groups	Total 6 2 × 3 relay 3 A	Total 11 2 × 3 relay 3 A 2 × 2 relay 3 A 1 × relay 16 A	Total 19 4 × 3 relay 3 A 2 × 2 relay 3 A 3 × 1 relay 16 A
Galvanic isolation	Yes (even groups each other)	Yes (even groups each other)	Yes (even groups each other)
Switching voltage		min. 5 V DC; 24 V DC; max. 30 V DC, max. 250 V AC	
Relay outputs groups	DO1 ÷ DO3, DO4 ÷ DO6	DO1 ÷ DO3, DO4 ÷ DO6, DO7 ÷ DO8, DO9 ÷ DO10	DO1 ÷ DO3, DO4 ÷ DO6, DO7 ÷ DO9, DO10 ÷ DO12, DO13 ÷ DO14, DO15 ÷ DO16
Switching current	Min. 100 mA; max. 3 A	Min. 100 mA; max. 3 A	Min. 100 mA; max. 3 A
Inrush current	5 A/<3s	5 A/<3s	5 A/<3s
Time of close/open the contact	typ. 10 ms/4 ms	typ. 10 ms/4 ms	typ. 10 ms/4 ms
Current through common wire	10 A	10 A	10 A
Switching frequency without load	max. 120 min <sup>-1</sup>	max. 120 min <sup>-1</sup>	max. 120 min <sup>-1</sup>
Switching frequency with nominal load	max. 30 min <sup>-1</sup>	max. 30 min <sup>-1</sup>	max. 30 min <sup>-1</sup>
Mechanical/Electrical lifetime at maximal load	5 × 10 <sup>6</sup> /1 × 10 <sup>5</sup>	5 × 10 <sup>6</sup> /1 × 10 <sup>5</sup>	5 × 10 <sup>6</sup> /1 × 10 <sup>5</sup>
Short-circuit protection	No	No	No
Spike suppressor of inductive load	External (RC, varistor, diode)	External (RC, varistor, diode)	External (RC, varistor, diode)
Insulation voltage between each relay outputs	3750 V AC	4000 V AC	4000 V AC
Connections/Conductors cross-section	Removable conector/max. 2.5 mm <sup>2</sup>	Removable conector/max. 2.5 mm <sup>2</sup>	Removable conector/max. 2.5 mm <sup>2</sup>

Relay outputs		DO11	DO17, DO18, DO19
Switching current		16 A	16 A
Inrush current		160 A/<10ms	160 A/<10ms
Time of close/open the contact		max. 10 ms/4 ms	max. 10 ms/4 ms
Minimal switched current		100 mA	100 mA
Switching frequency without load		max. 60 min <sup>-1</sup>	max. 60 min <sup>-1</sup>
Frequency of switching with nominal load		max. 6 min <sup>-1</sup>	max. 6 min <sup>-1</sup>
Mechanical/Electrical lifetime at maximal load		5 × 10 <sup>6</sup> /4 × 10 <sup>4</sup>	5 × 10 <sup>6</sup> /4 × 10 <sup>4</sup>
Short-circuit protection		No	No
Spike suppressor of inductive load		External	External
Insulation voltage between each relay outputs		3750 V AC	3750 V AC
Connections/Conductors cross-section			Fixed screw type terminals/max. 4 mm <sup>2</sup>

Dimensions and weight	C-HM-0308M	C-HM-1113M	C-HM-1121M
Dimensions	90 × 58 × 53 mm	90 × 105 × 58 mm	157 × 90 × 58 mm
Weight	125 g	270 mA	450 mA

Power supply	C-HM-0308M	C-HM-1113M	C-HM-1121M
Input nominal voltage (SELV)/	+24 – 27.2 V DC/from bus CIB	+24 – 27.2 V DC/from bus CIB	230 V AC
Nominal load	90 mA	160 mA	35 mA

Operating conditions	
Operating temperature	–10 .. +55 °C
Storage temperature:	–25 .. +70 °C
Electric strength	according EN 60950
IP Degree of protection(IEC 529)	IP 20, IP40 with cover in switchboard
Overvoltage category	II
Degree of pollution IEC EN 60664-1:2004	1
Working position	any
Installation	on DIN rail

Order number	
TXN 133 24	C-HM-0308M – CIB – combined module 3 × AI/DI, 2 × AO, 6 × RO 230 V 3 A
TXN 133 10	C-HM-1113M – CIB – combined module 3 × AI, 8 × DI (dry contact), 2 × AO, 10 × RO 230 V 3 A, 1 × RO 230 V 16 A
TXN 133 11	C-HM-1121M – CIB – combined module 3 × AI, 8 × DI (dry contact), 2 × AO, 16 × RO 230 V 3 A, 3 × RO 230 V 16 A



C-HM-0308M

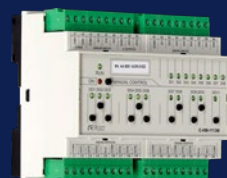

C-HM-1113M



C-HM-1121M

Type	DI	DO	AI	AO	Comm
<b>C-DM-0006M ULED</b>				6 × Voltage control (0 – 100%)	CIB

## Basic features

- Module is actuator with 6 independent outputs (channels) for proportional control of LED strip lighting with common anode. They are controlled by voltage.
- Each channel is independently addressed and controlled in range 0 up to 100% of power supply voltage 12 V or 24 VDC.
- All LED strips must be for the same power supply voltage.
- Outputs have internal protection against short-circuit.
- Module can be turned to manual mode by the front button, so each channel can be switched on/off by the channel button.
- Status is indicated by LED on module.

- CIB bus is connected at removable screw terminals.
- Outputs are available at removable screw connectors.
- Power voltage 12 V or 24 V DC for LED strips is connected at screw terminals with large cross-section.
- During designing the wiring, load of each terminal has to be taken into account.
- Module is used for assembly on DIN rail in switchboard.

## Use

- Control of up to 6 single-color LED strips with max. current 6 A per channel.
- Control of up to 2 RGB LED strips with up to 6 A per each color.
- Use for low power orientation lighting in buildings etc.
- May be used for decoration and effect lighting in interiors and exteriors.



C-DM-0006M ULED

## Connection

- Modul has to be connected to 2-wire bus CIB which provides both communication and power supply.

## Connection example

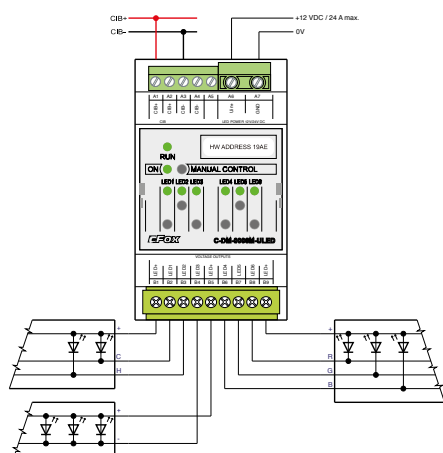

## Outputs for continuous control of LED strips

No. and type of outputs	6 x, semiconductor, PWM voltage output (0 – 100%)
Load type	LED strip, RGB/monochrom
Power voltage for LED strips	12 V DC/24 V DC
Output current	max. 6 A/channel
Maximal total current	24 A
Max. length of LED strip (13 W/m)	10 m
Max. length of LED strip (6.5 W/m)	20 m
Max. length of LED strip (4.3 W/m)	30 m
Short-circuit protection on output	Yes
Galvanic isolation of output	No

## Operating conditions

Operating temperature	0 .. +45 °C
Storage and transport temperature	-25 .. +85 °C
Electric strength	according EN 60730
IP Degree of protection(IEC 529)	IP10B
Overvoltage category	II
Degree of pollution IEC EN 60664-1:2008	1
Working position	vertical
Installation	on DIN rail
CIB connection	Screw terminals max. 2.5 mm <sup>2</sup>
Power supply connection	Screw terminals max. 4 mm <sup>2</sup>
LED strip connection	Screw connector, max. 2.5 mm <sup>2</sup>

## Dimensions and weight

Dimensions	53 × 90 × 58 mm
Weight	120 g

## Power supply

External power supply for LED strip	12/24 V DC ± 10%
Max. load current of LED	24 A total, 6 A per channel
Power supply of module and communication	24 V (27 V) from CIB bus
Typ. /max. load current from CIB	max. 15 mA
Typical/Max. power from CIB	0.4 W
Internal protection	Yes, recovering fuse

## Order number

TXN 133 45	C-DM-0006M ULED, 6 channel dimming module for LED strips 12 – 24 VDC, max. 4 A/channel
------------	--

Type	DI	DO	AI	AO	Comm
<b>C-DM-0006M ILED</b>				6 × controlled current supply (0 – 100%)	CIB

## Basic features

- Module is actuator with 6 independent outputs (channels) for proportional control of power LED lights or lights with LED chips connected in serial. They are controlled by control of the current.
- Each channel is independently addressed and controlled in range 0 up to 100% of the current range.
- Module can be switched by button into manual mode, so each output can be independently switched on and off by button.
- Status and error/operation is indicated by LED on module.

- CIB bus is connected at screw terminals.
- Outputs are connected at removable screw connector. During designing the wiring, allowed load of each terminal has to be taken into account
- Module is used for assembly on DIN rail in switchboards.

## Use

- Direct control of LED lights equipped by LED chips.
- Channels may be associated by triplets for fully independent control of two RGB light sources.
- May be used for decoration and effect lighting in interiors and exteriors.



C-DM-0006M ILED

## Connection

- Module has to be connected by two-wire bus CIB, that provides communication and power supply of module.

## Connection example

Connection of 6 LEDs individually controlled

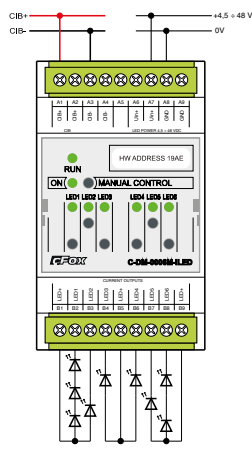

## Proportional outputs for LED chip control

Number and type of outputs	6 x, semiconductive current output, controlled PWM (0 – 100%)
Load type	LED chip, RGB/monochromatic
Power voltage for LED	4.5 – 48 V
Output current	150, 350, 500, 700 mA/channel
Max. number of white LEDs (48 V)	13 (3.5 V/1 diode)
Max. number of red LEDs (48 V)	22 (2.1 V/1 diode)
Max. number of green LEDs (48 V)	19 (2.6 V/1 diode)
Max. number of blue LEDs (48 V)	13 (3.5 V/1 diode)
Short-circuit protection on output	Yes
Galvanic isolation of output	No

## Power supply LED

Power supply voltage for LED in serial	4.5 – 48 V DC
Max. load current LED	4.2 A total, 700 mA per channel

## Operating conditions

Operating temperature	0 .. +55 °C
Storage and transport temperature	-25 .. +70 °C
Electric strength	according EN 60730
IP Degree of protection(IEC 529)	IP10
Overvoltage category	II
Degree of pollution	1
Working position	vertical
Installation	on DIN rail
Connections CIB	screw connector, max. 2.5 mm <sup>2</sup>
Connections Power supply	screw connector, max. 2.5 mm <sup>2</sup>
Connections LED belts	screw connector, max. 2.5 mm <sup>2</sup>

## Dimensions and weight

Dimensions	53 × 90 × 58 mm
Weight	120 g

## Power supply of module

Power supply of module	24 V (27 V) from CIB
Typical/max. load from CIB	15 mA
Typical/max. input power from CIB	0.4 W
Internal protection	Yes, recovering fuse

## Order number

TXN 133 46 C-DM-0006M ILED, 6 channel dimming module for LED chip 150, 350, 500, 700 mA/max. 48 V DC



# CIB – Universal dimming module RLC load on CIB bus 230 V/AC

Type	DI	DO	AI	AO	Comm
<b>C-DM-0402M RLC</b>			4x AI/DI	2x phase controlled voltage 230 V AC (0-100%)	CIB

## Basic features

- The module is an actuator with 2 independent outputs (channels) for proportional control of light sources powered by 230 V AC.
- Dimmer is well designed for high reliability and immune to interferences in the main and interference of ripple control.
- Each channel is individually addressable and controlled via CIB bus in range 0-100%.
- Module may be switched to manual mode, where each inputs may be switched on/off by button.
- The right function for loads of various characters RL, LC or LED/CFL is to be chosen in SW configuration of module via CIB.
- Each channel may control load up to 500 VA.
- Channels enable parallel arrangement of both output channels for increasing of controlled load up to 1 000 VA.
- To increase controlled load, we may parallelly arrange up to 4 outputs of independent modules. In such case both modules have to be on one branch CIB.
- In the case of parallel arrangement, all channels have to be control synchronal by the same commands via CIB bus. In the case of manual control, other active outputs may be overloaded.
- Outputs have internal protection against overload and overheating.

- Module contains 4 universal inputs for general purpose.
- To universal inputs we may connect voltage-free contacts, RTD temperature sensors or double-balanced circuits with security detectors.
- Status is indicated by LED on module.

## Connection

- The module is connected on two wires CIB bus, which holds communication, power supplying and control of module.
- CIB bus, inputs and outputs are connected to screw terminals.
- While designing the project, we have to calculate allowed load capacity of each connector.
- The module is designated for assembly into distribution box on DIN rail.

## Use

- Resistance load control up to 500 VA (resp. 1 000 up to 2 000 VA with parallel arrangement).
- Inductive load (RL) control up to 500 VA on channel. Typically standard transformers, motor loads, bulbs.
- Capacity load (RC) control up to 500 VA. Typically electronic transformers, Compact Fluorescent Lamp and LEDs on 230 V AC.



C-DM-0402M RLC

## Connection example

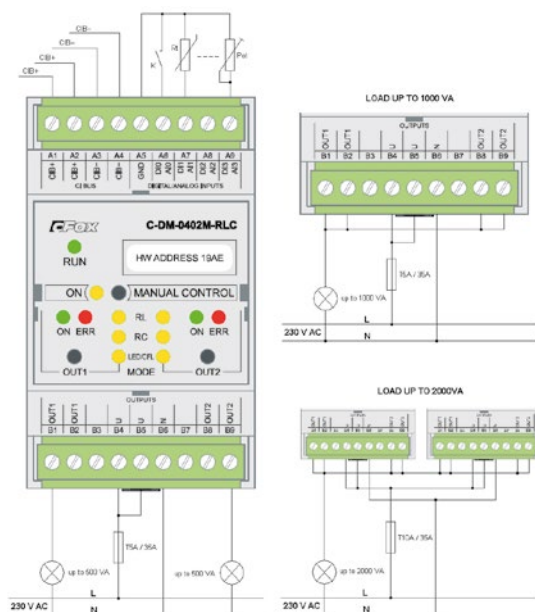

## Outputs for continuous load control 230 V AC

<b>Number and type of outputs</b>	2x 0-100%, phase control, 2x NMOS power transistor
<b>Load type</b>	R, L, C, dimmable LED and CFL
<b>Operation voltage</b>	230 V AC
<b>Output current</b>	max. 2,2 A/channel
<b>Switched load on channel</b>	500 VA (1000 VA, 2000 VA at parallel arranging)
<b>Galvanic separation of outputs from CIB bus</b>	Yes – 3,75 kV

## Measured ranges

Sensor type	Range	Basic accuracy
Voltage-free contact	0/1	0 if > 1.5 kΩ 1 if < 0.5 kΩ
Balanced output (security detectors)	Interrupted wire /0/1/tamper	for 2x 1k1 balanced resistor
Pt1000	-90 .. 320°C	0,5%
Ni1000	-60 .. 200°C	0,5%
NTC 12 k	-40 .. 125°C	0,5%
KTY81-121	-55 .. 125°C	0,5%
Resistor	0-160 kΩ	0,5%

## Dimensions and weight

<b>Dimensions</b>	90 x 58 x 53 mm
<b>Weight</b>	120 g

## Power supply of module

<b>Power supply for load</b>	230 V AC
<b>Max. output current of load</b>	2x 2,2 A in total
<b>Module power supply</b>	24 V (27 V) from CIB bus
<b>Typical load from CIB</b>	20 mA
<b>Typical/max. input power from CIB</b>	0.46 W
<b>Internal protection</b>	Yes, recovering fuse

## Operating conditions

<b>Operating temperature for load below 400 VA</b>	0 .. +40 °C; without forced circulation of air
<b>Operating temperature for load above 400 VA</b>	0 .. +40 °C, with forced circulation of air
<b>Storage and transport temperature</b>	-25 .. +85 °C
<b>Electric strength</b>	according EN 60730
<b>IP Degree of protection IP (IEC 529)</b>	IP20
<b>Overvoltage category</b>	II
<b>Degree of pollution</b>	1
<b>Working position</b>	vertical
<b>Installation</b>	on DIN rail
<b>Connection</b>	Screw connector
<b>Connections loads, inputs, CIB</b>	Screw connector max. 2,5 mm <sup>2</sup>

## Order number

TXN 133 58	C-DM-0402M-RLC, CIB – 2x dimmer RLC, 230 V AC, 2x 500 VA
------------	--

# CIB – Converter to DALI bus on DIN rail

Typ	DI	RO	AI	AO	Comm
<b>C-DL-0064M</b>					CIB, DALI

## Basic features

- Module is designated for control of electronic ballasts for fluorescent lamps, LED lights and other dimmers on DALI bus according to specification NEMA Standards Publication 243-2004 Digital Addressable Lighting Interface (DALI) Control Devices Protocols PART 2-2004.
- Module may control independently up to 64 ballasts, what is max. number on one branch according to DALI.
- Module is in design to fit in switching cabinet on DIN rail.
- Run of the module is indicated by LED diode.

## Connection

- Both DALI and CIB buses are connected to the module via screw terminals.

## Use

- Control of fluorescent lamps with DALI ballasts.
- Control of bulb dimmers equipped by DALI protocol.
- Control of LED dimmers equipped by DALI protocol.
- Independent switching on/off, smooth lights dimming, light scenes creation.
- Control of the module is supported by function blocks from library DalLib.mlb.



C-DL-0064M

## Connection example

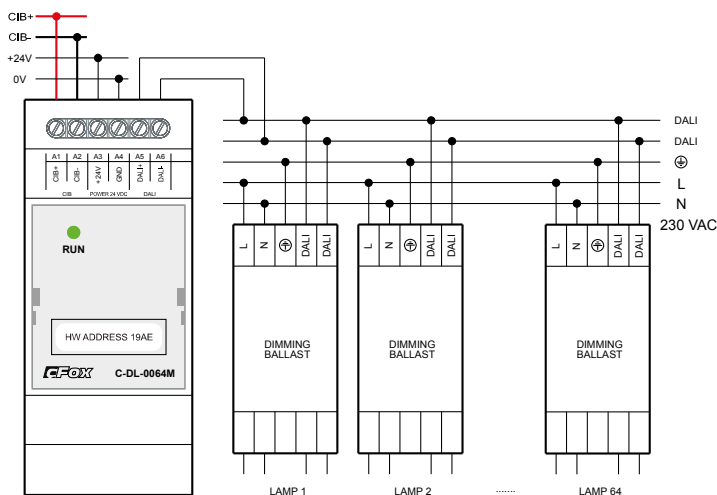

## Communication

<b>Installation bus</b>	CIB, Power supply is provided by an external source.
<b>Bus for ballasts control</b>	DALI, master function for one DALI branch. Module enables to address all 64 control ballasts. DALI output is powered directly from module.

## Operating conditions

<b>Operating temperature</b>	0 .. +70 °C
<b>Storage temperature</b>	-25 .. +85 °C
<b>Electric strength</b>	according EN 60730
<b>IP degree of protection IEC 529</b>	IP10B
<b>Overvoltage category</b>	II
<b>Degree of pollution according EN60664-1:2008</b>	1
<b>Operating position</b>	Any
<b>Installation</b>	On DIN rail into switching cabinet
<b>Connection DALI, CIB</b>	Screw terminals, 4mm <sup>2</sup>

## Dimensions and weight

<b>Dimensions</b>	106 × 92 × 35 mm
<b>Weight</b>	65 g

## Power supply

<b>Power supply and communication</b>	24 V (27 V) from external power source
<b>Nominal /max. load</b>	30 mA/320 mA
<b>Typical /max. input power</b>	0.75 W/7.6 W
<b>Internal protection</b>	Yes
<b>Load from CIB bus</b>	0 mA

## Order number

TXN 133 54 C-DL-0064M; CIB-DALI ballast, for 64 DALI ballasts

Type	DI	RO	AI	AO	Comm
<b>C-IR-0202S</b>		1	2	1	CIB
<b>C-IT-0200S</b>			2		CIB

## Basic features

- Modules C-IT-0202S and C-IT-0200S are both designed for connection of two temperature sensors or voltage-free contacts.
- C-IR-0202S is used for control tasks and therefore it is equipped by power contact of switching relay and analog output voltage.
- For temperature metering it is possible to connect directly resistance temperature detectors (RTD) Pt1000 or Ni1000, sensors with thermistor NTC 12k or NTC 160 k or semiconductor sensor KTY81 121.
- Module is designed in effective small built-in design into the installation box or into the measured/controlled device.

## Connection

- Modules are connected to CIB that ensures the communication and power supply by stranded wires finished with sleeves.
- Inputs and outputs are connected by stranded wires finished with sleeves too.

## Use

- Module C-IR-0202S with relay and analog output for: Temperature measurement and control of heating valve 230 V AC.
- Designing the application the maximum load of each terminal must be taken into account.
- Module C-IT-0202S is used for measurement of 2 temperatures, e.g. room temperature and floor temperature or for sensing contact outputs from different light controllers, detectors or security system sensors.



C-IR-0202S



C-IT-0200S

Relay outputs	C-IR-0202S	C-IT-0200S
Number of outputs	1	-
Galvanic isolation	Yes	
Switching voltage	max. 230 V AC	
Switching current	min. 100 mA; typ. 3 A; max. 5 A (beware the peak current of electronic loads)	
Time of close/open the contact	typ. 10 ms/4 ms	
Switching frequency without load	max. 300 min <sup>-1</sup>	
Switching frequency with nominal load	max. 20 min <sup>-1</sup>	
Mechanical/Electrical lifetime at maximal load	5 × 10 <sup>6</sup> /2 × 10 <sup>5</sup>	
Short-circuit protection	No	
Spike suppressor of inductive load	External (RC unit, varistor, diode)	
Insulation voltage against surrounded circuits	4000 V AC	

Analog inputs	C-IR-0202S	C-IT-0200S
Number of inputs	2	2
Galvanic isolation	no	no
Resolution	12 bit	12 bit
Measurement ranges		
RTD	Pt1000, Ni1000, (temperature range according to sensor type)	Pt1000, Ni1000, (temperature range according to sensor type)
NTC (thermistor)	12 kΩ, KTY81-121	12 kΩ, KTY81-121
Resistance	160 kΩ	160 kΩ
Potential-free contact	Yes, on each input	Yes, on each input
Balanced inputs for security systems sensors	Yes, on each input	Yes, on each input
Measured temperature accuracy	0.1 °C	0.1 °C

Operating conditions	
Operating temperature	0 .. +55 °C
Storage temperature	-25 .. +70 °C
Electric strength	according EN 60950
IP Degree of protection IEC 529	IP 10B
Overvoltage category	II
Degree of pollution IEC EN 60664-1:2004	1
Working position	any
Installation	Into installation box or into the device
Connections	Flat ribbon cable, the wires terminated with sleeves
Conductors cross-section	0.15 mm <sup>2</sup>
Power output	relay output 0.5 mm <sup>2</sup>

Analog outputs	C-IR-0202S	C-IT-0200S
Number of outputs	1	
Galvanic isolation	no	
Resolution	8 bit	
Output ranges	0 ÷ 10V, 1 ÷ 10V	

Dimensions and weight	C-IR-0202S	C-IT-0200S
Dimensions	55 × 26 × 20 mm	55 × 26 × 16 mm
Weight	7 g	3 g

Power supply	C-IR-0202S	C-IT-0200S
Power supply and communication	24 V (27 V) from CIB bus	24 V (27 V) from CIB bus
Typical load	18 mA	10 mA
Max. consumption	25 mA	12 mA

## Order number

TXN 133 25	C-IR-0202S, CIB, 2 × AI/DI, 1 × AO (0 – 10 V), 1 × RO 230 V AC/3 A, Temperature/contact sensing
TXN 133 29	C-IT-0200S, CIB, 2 × AI/DI; Temperature, voltage or voltage-free contact sensing

# CIB – Fan Coil controller with continuous regulation of fan revolutions

Type	DI	DO	AI	AO	Comm
<b>C-FC-0024X</b>		2x RO	1x room temperature 1x exchanger temperature 1x window contact	1x	CIB

## Basic features

- Module C-FC-0024X is designated for control of few convectors equipped by 24V DC motors, controlled by signal 0-10V or PWM.
- Contains 3 AI/DI combined inputs for connection of contacts, e.g. windows contacts or temperature sensors.
- Module has two output relays and one output configurable by jumper as analog 0-10V or as PWM output.

## Connection

- Module is connected to two-wire CIB bus, which ensures communication and power supply of the module.
- Jumper allows to set, whether module is powered from independent power source or from CIB bus. In position ACTIVE module provides powering of CIB bus.

## Use

- Module is designated as built-in model to floor convectors and fan coils.
- Module and its inputs and outputs may be used via bus as universal I/O module.



## Example connection

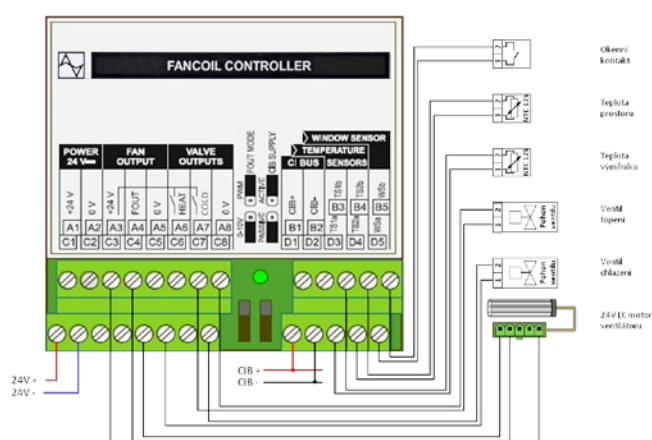

## Analog/digital inputs TS1, TS2, WS

Number of inputs	3
Galvanic isolation	No
Resolution	12bit, approximation converter
Common wire	plus
External power supply	No
Input resistance	4.7 kΩ
Interrupted input detection	No

Measured ranges:		
Sensor type	Range	Basic accuracy
Voltage-free contact	Switch on/off	
NTC 12k	-40 .. 125°C	<3% of range
Resistance transmitter OV	0-600kΩ	

## Operating conditions

Operating temperature	0 .. +55 °C
Storage temperature	-25 .. +70 °C
Electric strength	according EN 60730-1 ed2:2001
IP Degree of protection IEC 529	IP 10
Overvoltage category	II
Degree of pollution according EN60664-1:2008	1
Operating position	vertical
Installation	Module is designated as built-in module to device
Connection CIB, AI/DI	Screw terminals, wire max 2.5 mm <sup>2</sup>

## Dimensions and weight

Dimensions	55 × 26 × 20 mm
Weight	7 g

## Power supply

Power supply and communication	24 V(27 V) from bus CIB
Nominal/max. load	22 mA/80 mA
Typ./Max. input power	0.5 W/1.9 W
Internal protection	Yes

## Order number

TXN 133 39.01 C-FC-0024X CIB, Fan Coil controller with 0-100% regulation of fan revolutions 24 V, 3x AI/DI, 2x RO

# CIB – Built in module with combined inputs/outputs

Type	DI	DO	AI	AO	Comm
<b>C-IT-0504S</b>			5 x AI/DI	4 x AO	CIB

## Basic features

- Module is designed for direct connection of resistive sensors, potential-free contacts and analog outputs 0–10 V on CIB bus.
- Universal inputs can be configured as analog or digital in two groups. First group contains 4 inputs, other one 1 input.
- Firmware of module linearizes characteristics of resistance sensor, optimizes accuracy of metering and calculates it to temperature, than it is transmitted into central unit.
- Inputs in digital mode can give the binary status 0/1 – on/off or they can work as double balanced inputs evaluating 4 statuses broken wire/off/alarm/tamper of security detectors.
- Status is indicated by LED at module (RUN).

## Connection

- Inputs, outputs and bus are connected via the spring terminals.

## Use

- Module is designed for connecting of wall switches equipped by different combinations of contact, resistance sensors and LED indicators with common cathode or other devices with analog inputs 0–10 V (dimmers etc.).
- Module can be used to connect low stroke wall switches of JUNG company: A2224, CD2224, LS2224, AL2224 Flat design with modules 3212TSM and 3224TSM, and of GIRA company: 2001xx
- Module can be used as integrated sensors of up to 5 temperatures.
- Module can be used as integrated controller of up to 4 dimmers/ballasts controlled by 0–10 V, resp. 1–10 V with connection of 4 control buttons and 1 measurement of temperature.



C-IT-0504S new version with screwless terminals



## Connection example

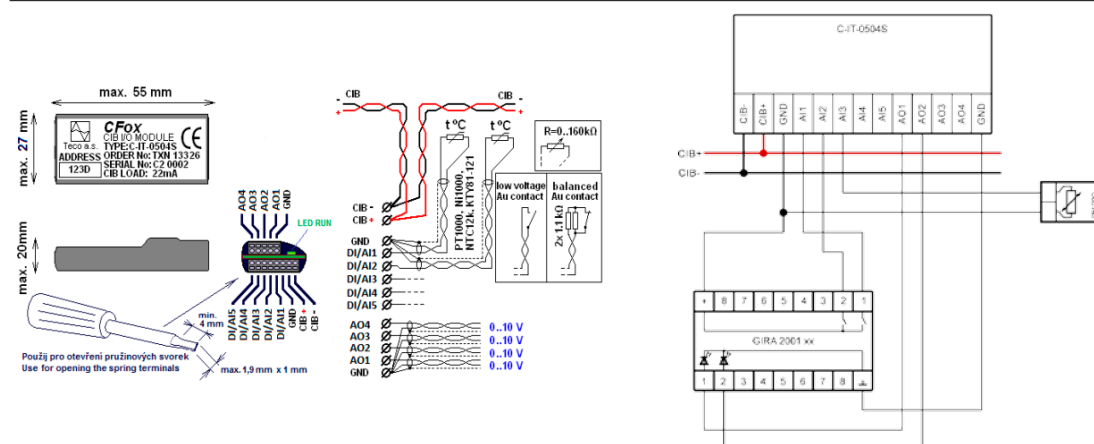

Examples of connected drivers

Drivers JUNG



Drivers GIRA

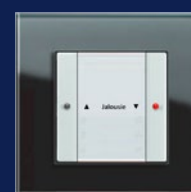

## Analog/universal inputs

Number of inputs	4+1
Galvanic isolation	No

Sensor type	Range	Basic accuracy
Potential free contact	0/1	0 if >1.5 kΩ 1 if <0.5 kΩ
Balanced input	interrupted wire 0/1/tamper	for 2 x 1k1 balanced resistor
Pt1000	-90 .. 320 °C	0.5%
Ni1000	-60 .. 200 °C	0.5%
NTC 12k	-40 .. 125 °C	0.5%
KTY81-121	-55 .. 125 °C	0.5%
Resistor	0–160 kΩ	0.5%

## Operating conditions

Operating temperature	0 .. +70 °C
Storage temperature	-25 .. +85 °C
Electric strength	according EN 60730
IP Degree of protection(IEC 529)	IP10B
Overvoltage category	II
Degree of pollution according IEC EN60664-1:2004	1
Working position	any
Installation	into installation box, under cover
Connections CIB and inputs/outputs	Spring-loaded terminals 0.15 to 0.5 mm <sup>2</sup>

## Analog outputs

No. of outputs	4 x
Galvanic isolation	No
Nominal output voltage	10 V
Adjustable range of outputs	0..130%
Min. resolution	1%
Max. output current	3 mA
Max. capacity load	250 nF

## Dimensions and weight

Dimensions	55 x 26 x 20 mm
Weight	7 g

## Power supply

Power supply and communication	24 V (27 V) from CIB bus
Nominal/max. load	22 mA/80 mA
Typical/maximal input power	0.5 W/1.9 W
Internal protection	Yes

## Order number

TXN 133 26	C-IT-0504S, CIB, 5 x AI/DI Temperature, contact, 4 x AO (0–10 V/3 mA)
------------	---





# CIB – Built-in module of combined inputs/outputs, built-in

Type	DI	DO	AI	AO	Comm
<b>C-IT-0908S</b>	6×DI	8×LED driver	2× AI/DI, 1× AI		CIB

## Basic features

- Module is designed for direct connection of potential-free contacts, resistance sensors and LED indicators to the CIB bus.
- Inputs IN1-IN6 are only digital, two inputs IN7-IN8 can be configured as analog or digital and input IN9 is only analog input.
- Firmware of module linearizes characteristics of several types resistance sensors, optimizes accuracy of measurement and recalculates resistance into temperature in Celsius degree, which is communicated via CIB bus into central module.
- Inputs in digital mode can give the binary status 0/1 – on/off or it can work as double balanced inputs evaluating 4 statuses broken wire/off/alarm/tamper of security detectors.
- Status is indicated by LED on module (RUN).

## Connection

- Module is connected at CIB bus by wires grouped at two connectors, that are inserted into module.
- CIB bus, contact inputs, Resistance Temperature Detectors

(RTD) and LED indicators are connected by stranded wires with sleeves. These wires are grouped at two connectors, inserted into module.

## Use

- Module can be used for connecting a combinations of wall switches with different combinations of contact and resistance sensors and LED indicators with common cathode (PNP outputs) or common anode (NPN outputs).
- Module can be used to connect low stroke wall switches. JUNG: A2224/48, CD2224/48, LS2224/48, AL2224/48 and Flat Design with modules 3212TSM and 3224TSM, 3236TSM, 3248TSM  
GIRA: line 2001xx or 2003xx for designs System55 and E22
- Module can be used as integrated temperature sensor of up to 3 temperatures.
- Module can be used as integrated driver of up to 8 LED indicators or other loads with maximal current 3 mA.



C-IT-0908S-PNP  
C-IT-0908S-NPN

## Examples of wall-switches connectable via C-IT-0908S



JUNG Flat Design (3248TSM)



JUNG design: LS, A



JUNG design: AL, CD

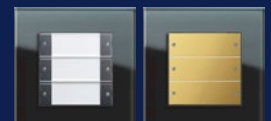

GIRA System55 and E22, (Transparent, Stainless steel, Aluminium, Brass, Bronze)

## Connection example

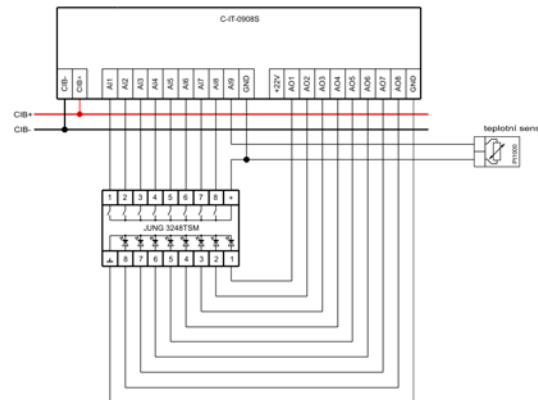
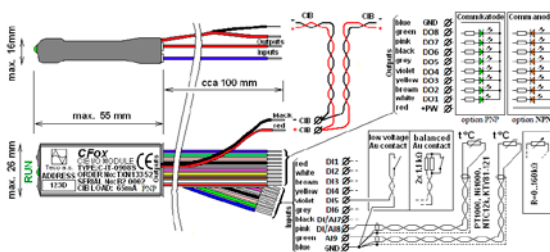

Connection of JUNG wall switch with 8 push-buttons and 8 LED indicators

## Analog/universal inputs

Number of digital inputs	6 × DI (IN1–IN6)
Number of universal inputs	2 × AI/DI (IN7–IN8)
Number of analog inputs	1 × AI (IN9)
Galvanic isolation	No

Sensor type	Range	Basic accuracy
Potential-free contact	0/1	0 for > 1.5 kΩ 1 for < 0.5 kΩ
Balanced input	Interrupted wire /0/1/tamper	for 2 × 1k1 balanced resistance
Pt1000	–90 .. 320°C	0.5%
Ni1000	–60 .. 200°C	0.5%
NTC 12k	–40 .. 125°C	0.5%
KTY81-121	–55 .. 125°C	0.5%
Resistance	0 – 160 kΩ	0.5%

## Operating conditions

Operating temperature	0 .. +70 °C
Storage temperature	–25 .. +85 °C
Electric strength	according EN 60730
IP Degree of protection(IEC 529)	IP10B
Overvoltage category	II
Degree of pollution according to IEC EN60664-1:2004	1
Working position	any
Installation	into installation box, under cover
Connection of inputs, outputs and CIB	Wires 0.5 mm <sup>2</sup> grouped on 2 connectors inserted into module

## Binary outputs for LED indicators

Number of outputs	8 × PNP open collector, 8 × NPN (with suffix.01)
Galvanic isolation	No
Polarity of LED connection	TXN 133 52: Common cathode TXN 133 52.01: Common anode
Max. voltage applicable	27 V
Max. output current	3 mA

## Dimensions and weight

Dimensions	55 × 26 × 20 mm
Weight	7 g

## Power supply

Power supply and communication	24 V (27 V) from CIB bus
Nominal/max. load	30 mA/65 mA
Typical/max. input power	0.8 W/1.6 W
Internal protection	No

## Order number

TXN 133 52	C-IT-0908S-PNP; CIB, 6× DI, 2× AI/DI, 1× AI (contact or resistance), 8× LED driver 3 mA, open collector PNP
TXN 133 52.01	C-IT-0908S-NPN; CIB, 6× DI, 2× AI/DI, 1× AI (contact or resistance), 8× NPN LED driver 3 mA

Type	DI	DO	AI	AO	Comm
<b>C-RI-0401S</b>	See AI		2 AI/DI, 1 × light sensor		CIB, IR

## Basic features

- Module is combined module with primary function of receiver and transmitter of IR commands.
- Module can learn IR commands of remote controllers of different devices – air-conditioning unit, audio/video devices etc. and store them in module memory. Subsequently, these commands can be reproduced by module transmitter on the base of signal from system.
- This is the way how to replace manual control by Foxtrot system.
- Module contains input for the light sensor.
- Module contains 2 universal AI/DI inputs for temperature sensors or potential-free contacts.
- These inputs can operate also as double balanced inputs for connection of security sensors.
- Status is indicated by LED on module.

## Connection

- Module is connected to two-wire CIB bus that provides both communication and power supply of module.
- Module is designed mostly for assembly into standard installation boxes in the wall or under device cover.
- Inputs, outputs and CIB bus are connected by stranded wires with sleeves.
- Module can be individually customized and built-in into the covers of wall switch design under the code C-RI-0401R-Design. Standard design is Time by ABB.

## Use

- Integration of infra red remote controlled devices. For example:
  - Interior air-condition units
  - audio, video
  - consumer electronics with IR control
- Measurement of light in interiors.
- Light intensity control in interiors.
- Specific sequence of actions can be defined in the system to expand the basic features of the original IR remote controller.

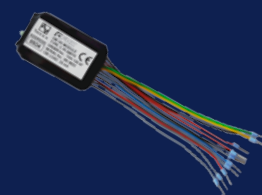

C-RI-0401S

## Connection example

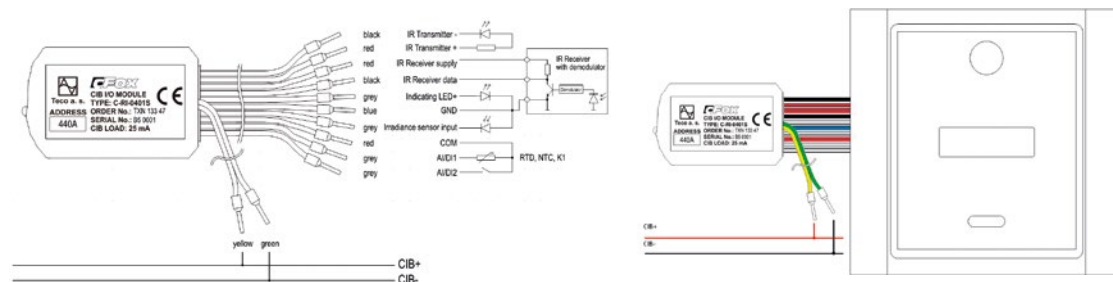

Variant:  
C-RI-0401R-Design

## IR receiver

Number of receivers	1
Galvanic isolation	No
Power supply of receiver-demodulator	3.3 V
Pilot frequency of demodulator	36 kHz

## IR transmitter

Number of transmitters	1
Galvanic isolation	No
IR transmitter type	IR LED ( $I_{f,max} = 100 \text{ mA}$ ) + resistor according $I_f$
Power supply of transmitter	3.3 V
Short-circuit protection	No

## Input for light sensor

Number of inputs	1
Galvanic isolation	No
Sensor type/range/input error	photodiode, 0 – 50 000lx / <5%

## Operating conditions

Operating temperature	-20 .. +55 °C
Storage temperature	-25 .. +70 °C
Electric strength	according EN 60730
IP Degree of protection(IEC 529)	IP 10B
Overvoltage category	II
Degree of pollution IEC EN60664-1:2008	1
Working position	any
Installation	into installation box, under cover
Connection of CIB, AI/DI	Wires 0.5 mm <sup>2</sup> , grouped on 2 connectors inserted into module

## Analog/digital inputs

No. of inputs	2
Galvanic isolation	No
Resolution	12 bit

## Measurement ranges

Sensor type	Range
Potential-free contact	on/off
Balanced input (security system)	broken link/0/1/tamper
Pt1000	-90 .. 320 °C
Ni1000	-60 .. 200 °C
NTC 12k	-40 .. 125 °C
KTY81-121	-55 .. 125 °C
Resistance	0 – 160 kΩ
Analog input error	< 2 %

## Dimensions and weight

Dimensionsy	55 × 32 × 13 mm
Weight	8 g

## Power supply

Power supply and communication	24 V (27 V) from CIB bus
Typical load	25 mA
Maximal input power	0.5 W
Internal protection	No

## Order number

TXN 133 47	C-RI-0401S; CIB input module for sensors 1 × IR, 1 × lighting, 2 × temperature, 1 × output for IR transmitter
------------	---

Type	DI	DO	AI	AO	Comm
<b>C-DL-0012S</b>					CIB, DALI

## Basic features

- Module is designed to control electronic ballasts, for fluorescent tubes, LED lights and other dimmers via DALI bus according specification of NEMA Standards 243-2004: Digital Addressable Lighting Interface (DALI). Control devices protocol PART 2-2004.
- Module can control independently up to 12 ballasts.
- Module is in minimal built-in design.
- Operation of module is indicated by LED diode.

## Use

- Control of fluorescent tubes with DALI ballasts.
- Control of lamp dimmers equipped with DALI protocol.
- Control of LED dimmers equipped with DALI protocol.
- Independent switching on/off, smooth dimming of lights, scene creating.
- Control of module is supported by function blocks from library Dalilib in Mosaic.



C-DL-0012S

## Connection

- Module is connected with two wires at CIB bus, that ensures communication and power supply of module.
- Module is connected into DALI bus via output that is led as well via two wires.

## Connection example

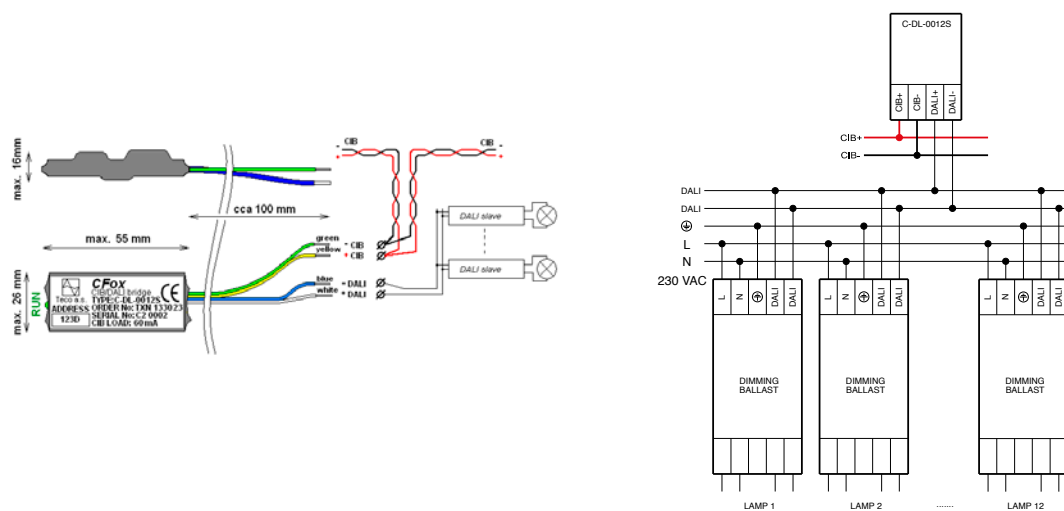

## Communication

Installation bus	CIB
Bus for ballast control	DALI, with MASTER function for max. 12 controlled ballasts, output for output for DALI supplied from CIB bus

## Operating conditions

Operating temperature	0 .. +70 °C
Storage temperature	-25 .. +85 °C
Electric strength	according EN 60730
IP Degree of protection (IEC 529)	IP10B
Overvoltage category	II
Degree of pollution IEC EN60664-1:2008	1
Working position	any
Installation	into installation box
Connection of CIB, DALI	stranded wires 0.5mm <sup>2</sup> with sleeves

## Dimensions and weight

Dimensions	50×26×20 mm
Weight	7g

## Power supply

Power supply and Communication	24 V (27 V) from CIB voltage
Typical load	60 mA
Typ./Max. input power	0.5 W/2 W
Internal protection	Yes

## Order number

TXN 133 23	C-DL-0012S; CIB-DALI converter, for 12 ballasts
------------	---

Type	DI	DO	AI	AO	Comm
<b>C-WG-0503S</b>	3 DI (TTL)	3 × DO (NPN)	2 AI/DI		Wiegand, CIB

## Basic features

- Universal module with combination of inputs, outputs, Wiegand communication line and integrated 12V DC power supply. This combination is suitable for connection of security, fire and access detectors on CIB bus in projects where security system does not need to be certified.
- Inputs IN1-IN3 on TTL level allows to connect external device via Wiegand interface to enable integrate the RFID card readers, security keyboard and similar devices via CIB.
- Inputs IN1-IN3 can be used as digital inputs on TTL level as alternative
- Module is equipped by two universal inputs IN4, IN5, that allow to connect standard security detectors with relay outputs via simply or double balanced loops.
- Module has integrated power supply 12V DC to supply detectors and other devices usually designed for that voltage.
- Module is further equipped by semiconductor outputs (NPN with open collector), which may be used as free programmable actuators according your opinion. For example for LED signaling, switch on the buzzer or opening door by external relay.

- Module is in miniature built-in design. In extreme cases may be built-in into detectors of security systems.
- Operation of module is indicated by LED diode.

## Connection

- Module is connected by two stranded wires to CIB, which provides both communication and power supply of the module.
- Detectors, readers with Wiegand interface and other devices are connected by wires available on connector, which is inserted into module.

## Use

- Sensing of standard or special detectors like PIR motion detectors, detectors of smoke, glass break etc.
- Connection of device communicating via Wiegand protocol.



C-WG-0503S

## Example of devices connectable to module C-WG-0503S



RFID readers SAMSUNG SSA R1000, SSA R1100 and reader with keyboard SSA R2000

## Connection example

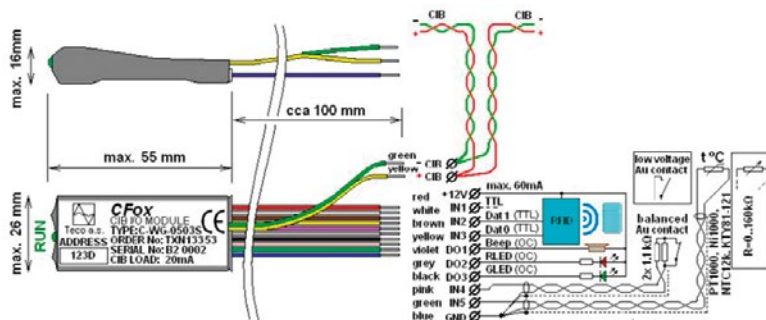

## Analog/combined inputs

Number of digital inputs	3 × DI (IN1–IN3), TTL 5 V
	3.9 kΩ pull up resistor
Number of universal inputs	2 × AI/DI (IN4–IN5)
Galvanic isolation	No

Sensor type	Range	Basic accuracy
Potential-free contact	0/1	0 for >1.5 kΩ 1 if <0.5 kΩ
Balanced input	broken wire /0/1/tamper	for 2 × 1k1 balancing resistance
Pt1000	–90 .. 320°C	0.5%
Ni1000	–60 .. 200°C	0.5%
NTC 12k	–40 .. 125°C	0.5%
KTY81-121	–55 .. 125°C	0.5%
Resistance	0 – 160 kΩ	0.5%

## Operating conditions

Operating temperature	0 .. +70 °C
Storage temperature	–25 .. +85 °C
Electric strength	according EN 60730
IP Degree of protection (IEC 529)	IP10B
Overvoltage category	II
Degree of pollution IEC EN60664-1:2008	1
Working position	any
Installation	into installation box, under device cover
Connection of CIB, inputs, outputs	Wires 0.5mm <sup>2</sup> . grouped on connector inserted into module

## Binary outputs

Number of outputs	3 × NPN, open collector
Galvanic isolation	No
Polarity of LED connection	Common anode
Max voltage:	30 V
Max. output switched current	30 mA

## Communication

Installation bus	CIB
Communication with reader, keyboard	Type of protocol: Wiegand Format: 26 bits, 34 bits, 42 bits, 40 bits transparent Number of bytes: 5, 4, 3, 5

## Power supply output 12 VDC

Output voltage	12 V DC
Output current (max.)	60 mA

## Dimensions and weight

Dimensions	55 × 26 × 16 mm
Weight	7 g

## Power supply

Power supply	24 V (27 V) from CIB
Max. load	85 mA
Typ./Max. input power	0.5 W/2.3 W
Internal protection	No



RFID readers Aktion AXR-100, AXR-200, AXR-300



PIR detectors Texcom Security systems



Fire detectors Texcom Fire alarm systems

## Order number

TXN 133 53	C-WG-0503S, CIB, 2 × AI/DI balanced, 3 × DO (NPN), 1 × Wiegand/3 × DI (TTL); output 12 V DC, connection of security system sensors
------------	--

Type	DI	RO	AI	AO	Comm
<b>C-OR-0202B</b>	See AI	2	2 AI/DI		CIB

## Basic features

- Module is an actuator with two independent relays 16 A with NO and NC contacts available.
- It is designed for switching of 2 independent power loads.
- Each relay is independently addressed and controlled.
- Module has 2 universal inputs for potential free contacts or resistive temperature sensors.
- Inputs can operate also as double balanced inputs for safety detectors. Inputs can be used to connect other resistive sensors up to 160 kΩ.
- Status of outputs and error/operation is indicated by LED on module.

- All relay contacts are led by isolated wires of 70 mm length.
- CIB bus and universal inputs are available on screw-type terminals.

## Use

- Module is designed for switching independent power loads and other devices by relay contacts.
- With appropriate connections of contacts of both relays which avoid the simultaneous presence of voltage on both output contacts, module can be used to control drives of shutters, blinds.
- During designing the wiring, load and protection of each output has to be taken into account.



C-OR-0202B

## Connections

- Module is connected on two wire CIB bus, providing both communication and power supply of module.
- Module is designed for assembly into standard installation box in the wall or under device cover.

## Connection example

Connection of DC motor and 2 temperature sensors

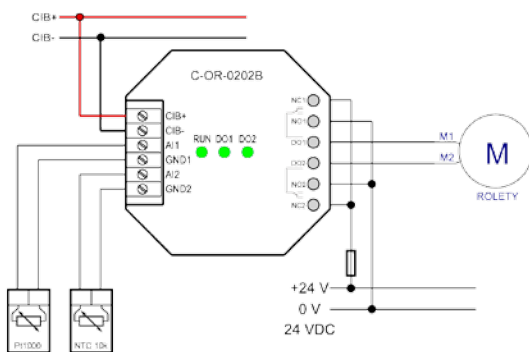

Connection of 230 V drives of shutters etc. and 2 push buttons.

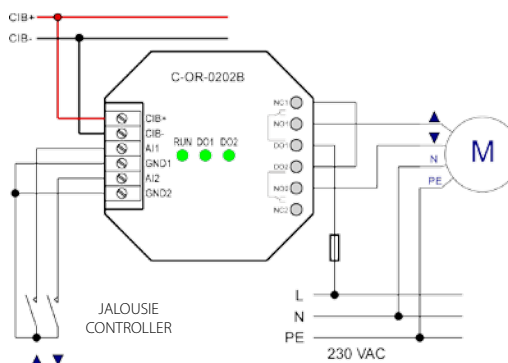

## Analog/combined inputs

Number of universal inputs	2 × AI/DI
Galvanic isolation	No

Sensor type	Sensor type	Basic accuracy
Potential-free contact	0/1	0 if >1,5 kΩ 1 if <0,5 kΩ
Balanced outputs	broken wire/0/1/ tamper	for 2 × 1k1 balancing resistance
Pt1000	-90 .. +320 °C	0,6°C
Ni1000	-60 .. +200 °C	0,6°C
NTC 12k	-40 .. +125 °C	0,6°C
KTY81-121	-55 .. +125 °C	0,6°C
Resistance	0 – 160 kΩ	

## Operating conditions

Operating temperature	-10 .. +55 °C
Storage temperature	-25 .. +70 °C
Electric strength	according EN 60950
IP Degree of protection(IEC 529)	IP 20B
Overvoltage category	I
Degree of pollution IEC EN60664-1:2004	1
Working position	any
Installation	into installation box
Connection of CIB, AI/DI	screw terminals max. 1.5 mm <sup>2</sup>
Relay outputs wire cross-section	6 × stranded wire H05 VK, 2.5 mm <sup>2</sup>

## Relay outputs

Number of outputs	2 × both NO, NC contacts 16 A/AC1
Galvanic isolation	Yes (even among outputs)
Switching voltage	min. 5 V DC; max. 300 V AC
Switching power	4000 VA/AC1, 384 W/DC
Switching current	max.16 A (NO), max.10 A (NC), min. 100 mA
Inrush current	80 A/<20 ms (NO contact)
Switch on/off time	typ. 15 ms/5 ms
Switching frequency without load	max. 1200 min <sup>-1</sup>
Frequency of switching with load	max. 6 min <sup>-1</sup>
Mechanical lifetime	3 × 10 <sup>7</sup>
Electrical lifetime	0.7 × 10 <sup>5</sup>
Short-circuit protection	No
Spike suppressor of inductive load	External (RC unit, varistor, diode)
Insulation voltage among each relay outputs	1000 V AC

## Dimensions and weight

Dimensions	50 × 50 × 30 mm
Weight	70 g

## Power supply

Power supply and communication	24 V (27 V) from CIB bus
Nominal load	50 mA (both relays closed)
Internal protection	Recovering fuse

## Order number

TXN 133 02	C-OR-0202B; CIB relay module 2 × RO 230 V AC/16 A; 2 × AI/DI
------------	--



Type	DI	DO	AI	AO	Comm
<b>C-VT-0102B</b>			1 × temperature	2 × fan	CIB

## Basic features

- Module is designed for proportional control of speed and rotation direction of two fans in heat recovery system inVENTer®
- Both fans are powered from the CIB bus.
- Module on CIB bus acts as two analog outputs 0–100% and one analog input for interior temperature measurement.
- Status is indicated by LED on module.

## Use

- Module is designed specifically to control fans of patented heat recovery system inVENTer. Together with these two fans, module is de facto heat recovery unit controlled and powered by CIB bus.
- Logic of both fans control in modes of heat recovery, dehumidification or charging is given by application program.

## Connection

- Module is connected to CIB bus by two wires. CIB provides both communication and power supply.
- Each fan is connected by 3 wires.
- Two screw type terminals are used for connection of temperature sensor.

## Connection example

Connection of two fans and one temperature sensor

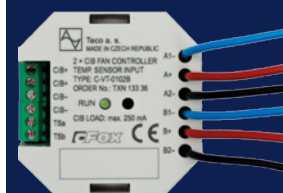
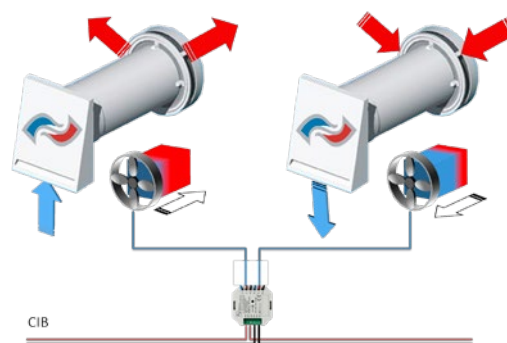
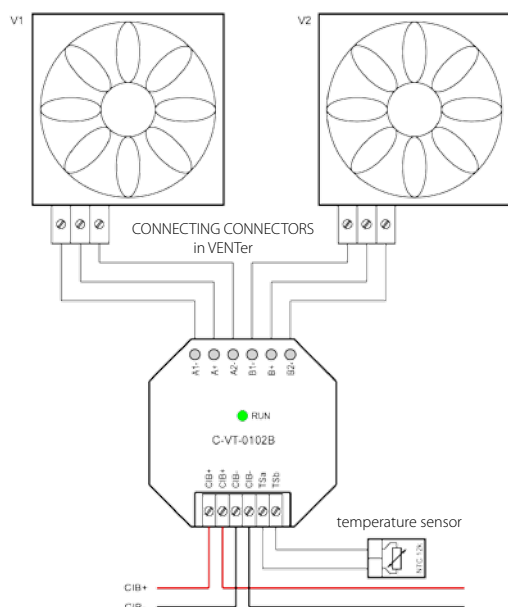

C-VT-0102B

## Outputs for fans

No. of outputs	2 ×
Output voltage	± 7..15 V DC, ± %
Output current	Max. 200 mA

## Analog input

Sensor type	Range	Basic accuracy
NTC 12k	−40 .. 90 °C	0.6 °C
Resistance	0–100 kΩ	

## Operating conditions

Operating temperature	0 .. +70 °C
Storage temperature	−25 °C..+85 °C
Electric strength	according EN 60730
IP Degree of protection (IEC 529)	IP 10B
Overvoltage category	II
Degree of pollution IEC EN60664-1:2008	1
Working position	any
Installation	into installation box, under cover
Connection of CIB, AI	screw terminals, max. 1.5 mm <sup>2</sup>
Outputs for fans	6 × wire H05 VK, 0.5 mm <sup>2</sup>

## Dimensions and weight

Dimensions	50 × 50 × 27 mm
Weight	38 g

## Power supply

Power supply and communication	24 V (27 V) from CIB bus
Typical/max. load from CIB	250 mA
Typical/max. input power form CIB	4 W/6 W
Internal protection	Recovering fuse

## Order number

TXN 133 36	C-VT-0102B, CIB, 2 × fan drive for inVENTer (± 15 V DC); 1 × AI for temperature sensor
------------	--

# CIB – Module of universal analog inputs with protection IP65

Type	DI	DO	AI	AO	Comm
<b>C-IT-0200I</b>			2×AI		CIB

## Basic features

- Module is designed as universal analog input on CIB bus with high IP protection for general use.
- Module allows to measure voltage, current, resistance, RTD and thermocouples, pH and Redox probes.
- The type of sensor and measured range is selectable by jumpers.
- Firmware of module linearizes characteristics of temperature sensor, optimizes accuracy of measurement and converts it on temperature in degrees, which is then transferred into central unit.

## Connection

- Module is connected to CIB bus providing both communication and power supply of module by cable through glands.

- Wires are connected via screw-less terminals accessible after opening.
- Module can be fixed on the device surface or on the wall.

## Use

- Module can be used as remote converter of analog signal in place of measurement and long distance transmission in digital form via installation bus CIB with use of all its advantages, e.g. transmission up to 500 m, any branches and as well power supply via CIB bus.
- For power supply of current loops there is no need of separate wires, power supply comes from CIB bus.
- High protection enables to install module very close to measured value in any environment.
- Module can be used for measurement of very low voltage, from pH and Redox probes, whose we use for example in pool technologies. The probe has to be calibrated before use.



C-IT-0200I

## Connection example

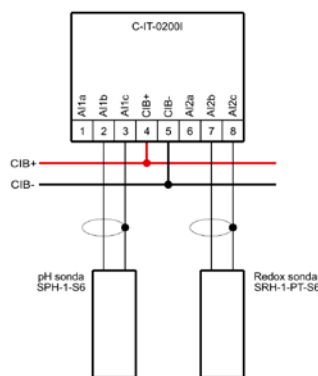
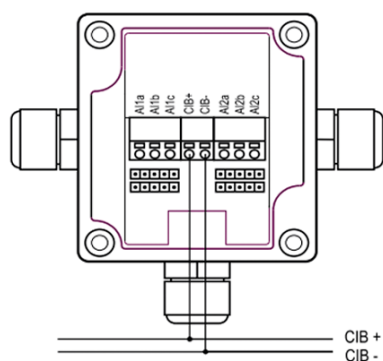

Example of connection pH and Redox probes

## Analog inputs

No. of inputs	2 ×
Galvanic isolation	No
Converter type/Resolution	SigmaDelta/16 bit
Analog input error	<2% (according to used range)
Compensation of cold end of thermocouple	Yes
Input range of internal thermometer	-20... 80°C

Sensor type	Range	Input impedance
Voltage U	0÷10 V; 0÷5 V; -2÷2 V; -1÷1 V	54.6 kΩ
Voltage U (HI)	HI: -1÷1 V, HI: -100+ 100mV	4 MΩ
Current I	0÷20 mA 4÷20 mA	50 Ω

Sensor type	Range	Input impedance
Thermocouple type J	-210...+1200°C	4 MΩ
Thermocouple type K	-200...+1372°C	4 MΩ
Thermocouple type R	-50...+1768°C	4 MΩ
Thermocouple type S	-50...+1768°C	4 MΩ
Thermocouple type T	200...+400°C	4 MΩ
Thermocouple type B	250...+1820°C	4 MΩ
Thermocouple type N	-200...+1300°C	4 MΩ

Sensor type	Range	Input impedance
Pt1000 (W100= 1.365)	-90 .. 320°C	4.7 kΩ
Pt 1000 (W100= 1.391)	-90 .. 320°C	4.7 kΩ
Ni1000 (W100= 1.500)	-60 .. 200°C	4.7 kΩ
Ni1000 (W100= 1.617)	-60 .. 200°C	4.7 kΩ
NTC 12k	-40 .. 125°C	4.7 kΩ
KTY81-121	-55 .. 125°C	4.7 kΩ
Resistance	0–200 Ω	4.7 kΩ

## Operating conditions

Operating temperature	-10 .. +55 °C
Storage temperature	-25 .. +70 °C
Electric strength	according EN 60730
IP Degree of protection (IEC 529)	IP65
Overvoltage category	II
Degree of pollution according IEC EN60664-1:2008	1
Working position	any
Installation	On wall, on surface, holder, etc.
Connection of CIB	Screw-less free Push-in terminals 1.5 mm <sup>2</sup>

## Dimensions and weight

Dimensions	125 × 100 × 38 mm
Weight	120g

## Power supply

Power supply and communication	24 V (27 V) from CIB bus
Typical/max. load	15 mA/60 mA (at power supply of current loops)
Typical/Maximal input power	0.4 W/1.5 W
Internal protection	No

## Order number

TXN 133 09 C-IT-0200I; CIB; 2×AI; 0–10V, 4–20 mA, RTD, TC, IP65

Type	DI	DO	AI	AO	Comm
<b>C-AM-0400M</b>			4 × AI/DI		CIB
<b>C-AM-0600I</b>			5 × AI/DI 2 × AI for flow meter AV23		CIB

## Basic features

- Modules for CIB bus.
- Input AV23 of module C-AM-0600I is designed for direct connection of flow meter Taconova AV23.
- Universal inputs can be configured for measurement of voltage, current and resistance temperature sensors.
- Universal inputs can be also configured as impulse counters of energy meters – electricity meters, gas meters and water meters.
- Taconova AV23 flow meter interface has 2 inputs, one is used for sensing of proportional flow and the second for sensing the temperature of flowing liquid.

- Module firmware linearizes characteristics of resistance sensors, optimizes accuracy of measurement and recalculates it into temperature, which is further transmitted into central unit.

## Connection

- Modules are connected to the CIB bus.
- Module C-AM-0400M is connected over 2 screw-type connectors.
- Module C-AM-0600M with IP65 protection is connected over screwless push-in terminals under the cover

## Use

- As universal analog inputs on CIB bus.
- As universal counter inputs on CIB bus.
- As specialised module for connection flow meter Taconova AV23.

## Connection example

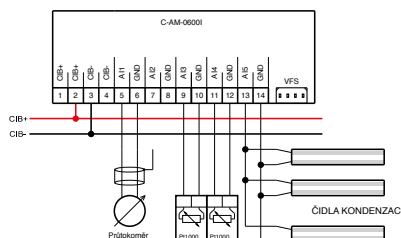
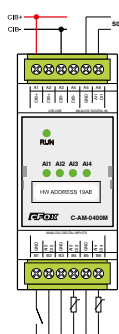

C-AM-0400M



C-AM-0600I

	C-AM-0400M	C-AM-0600I
<b>Number of inputs</b>	4 × AI/DI	5 × AI/DI
<b>Inputs for flow meter AV23</b>	No	1 × (AV23)
<b>External power supply</b>	No	No
<b>Reference voltage</b>	7.4 V	7.4 V

	C-AM-0400M	C-AM-0600I
<b>Binary inputs</b>		
<b>Number of inputs</b>	4 × AI/DI	5 × AI/DI
<b>Input type</b>	Active/pasive	Active/pasive
<b>Delay 0→1</b>	10 ms	10 ms
<b>Delay 1→0</b>	500 ms	500 ms

	C-AM-0400M	C-AM-0600I
<b>Impulse counter</b>		
<b>No. of inputs</b>	4 × AI/DI	5 ×
<b>Galvanic isolation</b>	No	No
<b>External power supply</b>	No	No
<b>Reference voltage</b>	24 V DC	AI1-AI4: 24 V DC AI5: 7.4 V
<b>Max. input current</b>	14 mA	14 mA
<b>Max. frequency</b>	20 Hz	20 Hz
<b>Minimal length of counted pulse</b>	>30 ms	>30 ms
<b>Measured range of thermo meter/Internal converter</b>	800Ω	800Ω

## Operation and installation conditions

<b>Operation temperature</b>	-10 .. +55 °C
<b>Storage temperature</b>	-25 .. +80 °C
<b>Electrical strength</b>	according EN 60730
<b>Degree of protection IP (IEC 529)</b>	IP55
<b>Overvoltage category</b>	II
<b>Degree of pollution according ČSN EN60664-1:2008</b>	1
<b>Operation position</b>	Any
<b>Installation</b>	On wall
<b>Connection of CIB and sensors</b>	Screwless push-in terminals 0.14÷1.5 mm <sup>2</sup>

## Order number

<b>TXN 133 51</b>	C-AM-0400M; CIB, 4 × AI/DI, module of analog inputs and reading energy meters
<b>TXN 133 50</b>	C-AM-0600I; CIB, 5 × AI/DI, 1 × AV23 flowmeter, module of analog inputs and reading energy meters, IP65 protection

Sensor type	Range	Basic accuracy
<b>Potential-free contact</b>	0/1	0 for >1.5 kΩ 1 for <0.5 kΩ
<b>Balanced input</b>	broken wire /0/1/tamper	pro 2 × 1k1 balancing resistor
<b>Pt1000</b>	-90 .. 320°C	0.5%
<b>W100=1.385/1.391</b>		
<b>Ni1000</b>	-60 .. 200°C	0.5%
<b>W100=1.500/1.617</b>		
<b>NTC 12k</b>	-40 .. 125°C	1%
<b>KTY 81-121</b>	-55 .. 125°C	0.5%
<b>Resistor OV 200k</b>	0 – 200 kΩ	10%
<b>Resistor OV 400k only for AI5</b>	0 – 400 kΩ	10%
<b>Voltage</b>	0÷10 V, 0÷2 V, 0÷1 V	0.5%
<b>Current</b>	0 – 20 mA, 4 – 20 mA	

## Interface features

of flow meter AV23	C-AM-0400M	C-AM-0600I
<b>Power supply voltage</b>		5 V DC
<b>Integrated power supply</b>		Yes
<b>Typical load from CIB</b>		3 mA
<b>Measured range of flow meter/Internal converter</b>		0.5 – 3.5 V 1 – 12 l/min or 2 – 40 l/min
<b>Input error</b>		0.5%
<b>Measured range of thermo meter/Internal converter</b>		0.5 – 3.5 V/0 – 100 °C
<b>Input error</b>		0.5%

## Dimensions and weight

	C-AM-0400M	C-AM-0600I
<b>Dimensions</b>	90 × 36 × 65	85 × 85 × 37 mm
<b>Weight</b>	75 g	65 g

## Power supply

<b>Power supply and communication</b>	24 V (27 V) from CIB bus
<b>Nominal/max. load</b>	40 mA/80 mA
<b>Typical/Maximal input power</b>	1 W/2 W
<b>Internal protection</b>	No

Type	DI	DO	AI	AO	Comm
<b>C-IT-0100H-A</b>			1 x temperature		CIB
<b>C-IT-0100H-P</b>			1 x temperature		CIB

## Basic features

- C-IT-0100H-A Temperature sensor in aluminium head with stem, IP54.
- C-IT-0100H-P Temperature sensor in plastic head with stem IP65.
- Available also as an outdoor temperature sensor, or surface contact sensor.
- Temperature is converted in sensor directly on numerical value and transmitted into central module via CIB bus.
- All units have built-in sensor of internal temperature in the head.
- The principle of processing the signal eliminates distortion resp. error of measurement by connection at long distance.

## Connection

- Sensors and converters are designed as standard units at two wires CIB bus, providing both communication and power supply of all sensor.
- Save wires: Free topology and branching up to distance 400 m, up to 32 units on 1 branch CIB.
- Master of CIB bus is basic module Foxtrot or extension module CF-1141.

## Use

- In applications of measurement and regulation.
- In air-conditioning, ventilation, local or centralised heating or cooling.
- Can be placed in exteriors or interiors.

Analog inputs	C-IT-0100H-A	C-IT-0100H-P
Main input/measured value	1 x temperature sensor at stem	1 x temperature sensor at stem
Supplement input	Temperature in converter head	Temperature in converter head
Measured temperature range	-50 °C ÷ + 250 °C	-20 °C ÷ + 200 °C
Resolution	0.1 °C	0.1 °C
Basic measurement accuracy	0.5 °C	0.5 °C
Calibration	From manufacturing	From manufacturing

Operating conditions	C-IT-0100H-A	C-IT-0100H-P
Operation temperature	-25 ÷ + 70 °C	-25 ÷ + 70 °C
Temperature of storage and transportation	-25 ÷ + 70 °C	-25 ÷ + 70 °C
Relative humidity	< 80 %	< 80 %
IP Degree of protection according IEC 529	IP54	IP65
Installation	Into the pipe, thermowell, on the wall (see optional accessories)	Into the pipe, thermowell, on the wall (see optional accessories)
Input wire assembly	1 x gland	1 x gland
Connection (CIB)	Firm terminals	Firm terminals
Conductors cross-section	1 mm <sup>2</sup>	1 mm <sup>2</sup>
Recommended diameter of wire	5 ÷ 7 mm	4 ÷ 8 mm

Dimensions and weight	C-IT-0100H-A	C-IT-0100H-P
Dimensions	90 x 71 x 200 mm	90 x 66 x 155 mm (without gland)
Standard length of stem	120 mm (other lengths see other variants)	115 mm (other lengths see other variants)
Weight	220 g	130 g

Power supply	C-IT-0100H-A	C-IT-0100H-P
Power supply/Voltage	From bus CIB/24 (27) V DC	From bus CIB/24 (27) V DC
Load from CIB bus	8 mA	8 mA

## Order number

TXN 133 17	C-IT-0100H-A, CIB, temperature sensor with stem, IP54, aluminium head
TXN 133 16	C-IT-0100H-P, CIB, temperature sensor with stem, IP65, plastic head



C-IT-0100H-A



C-IT-0100H-P



C-IT-0100H-P  
Surface contact



C-IT-0100H-P  
outdoor  
temperature

# CIB – Outside temperature and lighting sensor module

Type	DI	RO	AI	AO	Comm
<b>C-RI-04011</b>			1× lighting sensor 1× temperature sensor		CIB

## Basic features

- Combined sensor of temperature and lighting on CIB bus.
- Module is designated with IP54 protection for installation on the wall in exteriors.

## Connection

- Module is connected to two wires CIB bus, that ensures communication and power supply of module.
- CIB bus comes to module through gland by two wires cable up to diameter 7mm.

## Use

- Module is designated primarily for outside lighting metering.
- Module also measure outside temperature, because it is equipped by own temperature sensor.
- Module may be used in exterior and interior, where a high protection is needed.



C-RI-04011

## Connection example

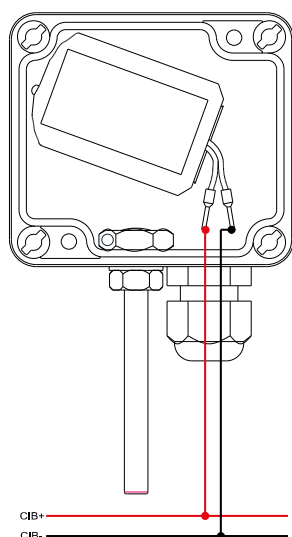

## Temperature sensor

Number	1
Galvanic isolation	No
Resolution	12 bit

## Measured ranges

Sensor type	Ranges	Accuracy
Pt1000 – W100=1.385	-90 .. 320°C	12 bit/< 2%

## Operating conditions

Operating temperature	-20 .. +55 °C
Storage temperature	-25 .. +70 °C
Electric strength	according EN 60730
IP Degree of protection IEC 529	IP54
Overtoltage category	II
Degree of pollution according EN60664-1:2008	1
Operating position	Vertical, gland down
Installation	In exterior by fixing on the wall by screws in installation holes
Connection	2 wires cable 4,5-7 mm via gland PG9

## Lighting sensor

Number	1
Galvanic isolation	No
Resolution	12 bit

## Measured ranges

Sensor type	Ranges	Accuracy
Photodiode	0-50 000 lx	12 bit/< 5%

## Dimensions and weight

Dimensions	74×125×39 mm
Weight	150 g

## Power supply

Power supply and communication	24 V (27V) from bus CIB
Nominal load	25 mA
Max. input power	0.5 W
Internal protection	No

## Order number

TXN 133 47.92 C-RI-04011, CIB combined module for outside lighting and temperature metering



# CFox

## Interior controllers

### Logus90 EFAPEL



C-Ws-0200R  
Logus



C-Ws-0400R  
Logus



C-It-0200R  
Logus



C-Rc-0002R  
Logus



C-Rc-0003R  
Logus



C-Ri-0401R  
Logus

### Time ABB



C-Ws-0200R  
Time



C-Ws-0400R  
Time



C-It-0200R  
Time



C-Rc-0002R  
Time



C-Ri-0401R  
Time



RCM2-1

### Decente Obzor

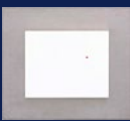

C-Ws-0200R  
Decente

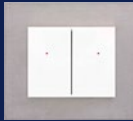

C-Ws-0400R  
Decente



C-It-0200R  
Decente



C-Aq-0001R  
CO2

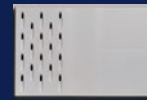

C-Aq-0002R  
VOC

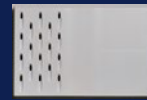

C-Aq-0003R  
Smoke

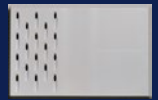

C-Aq-0004R  
humidity

### System 55 Merten, Gira



S-Ws-0200R  
Merten

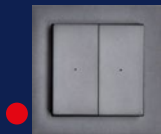

S-Ws-0400R  
Merten



C-It-0200R  
Gira



C-Rc-0002R  
Merten



C-Rc-0003R  
Gira



C-Ri-0401R  
Gira



S-Ws-0600R  
Gira

### Bticino Living Light Axolute



S-Ws-0200R  
Bticino Living



S-Ws-0400R  
Bticino Living



C-It-0200R  
Bticino Living



C-Rc-0002R  
Bticino Living



C-Rc-0003R  
Bticino Light

### Eaton Original, Pure. Intense

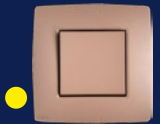

S-Ws-0200R  
Niko

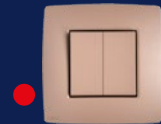

S-Ws-0400R  
Niko



C-It-0200R  
Niko



C-Rc-0002R  
Niko



S-Ws-0600R  
Niko

### Schneider Unica



S-Ws-0200R  
Unica



S-Ws-0400R  
Unica



C-It-0200R  
Unica



C-Rc-0002R  
Unica



C-Rc-0003R  
Unica

### Integration via



C-It-0200S



C-It-0504S



C-It-0908S

## Basic features

- Because of wide range of color and material combinations of covers and frames from LOGUS90 line, the cover and frame are ordered separately.

## Order codes

- Order numbers are mentioned below images.

White	Ivory	Ice	Pearl	Aluminium	Gray
-------	-------	-----	-------	-----------	------

### Covers for devices

90601 TBR-U1	90601 TMF-U1	90601 TGE-U1	90601 TPE-U1	90601 TAL-U1	90601 TIS-U1
90611 TBR-U1	90611 TMF-U1	90611 TGE-U1	90611 TPE-U1	90611 TAL-U1	90611 TIS-U1

### Covers with devices

LPA4-white	LPA4-ivory	LPA4-ice	LPA4-pearl	LPA4-aluminium	LPA4-gray
LCD1-L-white	LCD1-L-ivory	LCD1-L-ice	LCD1-L-pearl	LCD1-L-aluminium	LCD1-L-gray
LCD HL1-L-white	LCD HL1-L-ivory	LCD HL1-L-ice	LCD HL1-L-pearl	LCD HL1-L-aluminium	LCD HL1-L-gray
90677 TBR	90677 TMF	90677 TGE	90677 TPE	90677 TAL	90677 TIS

Frames, line Basic			Frames, line Aquarella		
--------------------	--	--	------------------------	--	--

90910 TBR White	90910 TGF Ivory	90910 TGE Ice	90910 TPE Pearl	90910 TAL Aluminium	90910 TIS Gray

### Frames, line Metallo

90910 TIA Inox, aluminium	90910 TOP Gold, aluminium	90910 TQS Nickel, gray	90910 TRS Chrom, gray	90910 TTP Titanium, pearl	90910 TUS Aluminium, gray

### Frames, line Arbore

90910 TFP Beech, pearl	90910 TJP Cherry-tree, pearl	90910 TMS Mahogany, gray	90910 TNA Walnut-tree, aluminium

### Frames, line Crystal

90910 TCA Glass, aluminium	90910 TCG Glass, ice	90910 TCP Glass, pearl	90910 TCS Glass, gray

### Frames, line Petra

90910 TGA Granite, aluminium	90910 TGG Granite, ice	90910 TGP Granite, pearl	90910 TGS Granite, gray

### CIB devices:



C-WS-0200R Logus  
TXN 133 56

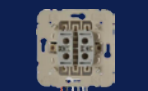

C-WS-0400R Logus  
TXN 133 57

### CIB bus interfaces:



C-IT-0200R-Design-Zak  
TXN 133 20



C-RC-0002R-Design-Zak  
TXN 133 33



C-RC-0003R-Design-Zak  
TXN 133 37

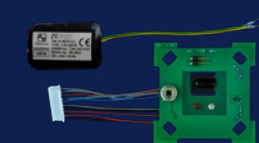

C-RI-0401R-Logus  
TXN 133 47.21  
TXN 133 47.22  
TXN 133 47.23

## Basic features

- Because of wide range of color and material combinations of covers and frames from Time line, the cover and frame are ordered separately.

## Order number

- Order numbers are mentioned below images.

White/ice white	White/white	Titanium	Old-fashioned silver	Champagne	Anthracite
-----------------	-------------	----------	----------------------	-----------	------------

### Covers for devices

3558E-A00651 01	3558E-A00651 03	3558E-A00651 08	3558E-A00651 32	3558E-A00651 33	3558E-A00651 34
3558E-A00652 01	3558E-A00652 03	3558E-A00652 08	3558E-A00652 32	3558E-A00652 33	3558E-A00652 34
5015E-A00200 01	5015E-A00200 03	5015E-A00200 08	5015E-A00200 32	5015E-A00200 33	5015E-A00200 34

### Covers with devices

LCD1-Ti-white/ice	LCD1-Ti-white/white	LCD1-Ti-titanium	LCD1-Ti-old-fashioned silver	LCD1-Ti-champagne	LCD1-Ti-anthracite
LCD-HL1-Ti-white/ice	LCD-HL1-Ti white/white	LCD-HL1-Ti titanium	LCD-HL1-Ti old-fashioned silver	LCD-HL1-Ti champagne	LCD-HL1-Ti anthracite
3902E-A00001-01	3902E-A00001-03	3902E-A00001-08	3902E-A00001-32	3902E-A00001-33	3902E-A00001-34

### Frames Time

3901F-A00110 01	3901F-A00110 03	3901F-A00110 08	3901F-A00110 32	3901F-A00110 33	3901F-A00110 34

### Frames Time Arbo

3901F-A50110-50	3901F-A50110-51	3901F-A50110-52	3901F-A50110-53

Natural beech	Alder-tree	Cherry-tree	Mahogany
---------------	------------	-------------	----------

### End caps Time

3902E-A00001-01	3902E-A00001-03	3902E-A00001-08	3902E-A00001-32	3902E-A00001-33	3902E-A00001-34

## CIB devices:



C-WS-0200R-Time  
TXN 133 30



C-WS-0400R-Time  
TXN 133 31



C-IT-0200R-ABB-Zak  
TXN 133 19

## Bus interfaces



C-RC-0002R-Time  
TXN 133 33



C-RC-0003R-Time  
TXN 133 37

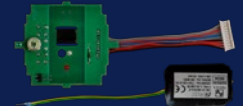

C-RI-0401R-Time  
TXN 133 47.01  
TXN 133 47.02  
TXN 133 47.03

# CIB – Wall switches controllers Element (ABB) Covers and frames

## Basic features

- Because of wide range of color and material combinations of covers and frames from Time/Element line, the cover and frame are ordered separately.

## Order number

- Order numbers are mentioned below images.

White ice white	White/white	White ice gray	Caramel ice gray	Ivory ice white	Agave ice gray	Carmine ice gray	Cofee/ice opal
-----------------	-------------	----------------	------------------	-----------------	----------------	------------------	----------------

### Covers for C-WS-0200R-Element



3558E-A00651 01 3558E-A00651 03 3558E-A00651 04 3558E-A00651 07 3558E-A00651 21 3558E-A00651 22 3558E-A00651 24 3558E-A00651 25

### Covers for C-WS-0400R-Element



3558E-A00652 01 3558E-A00652 03 3558E-A00652 04 3558E-A00652 07 3558E-A00652 21 3558E-A00652 22 3558E-A00652 24 3558E-A00652 25

### Covers for C-IT-0200R-Element



5015E-A00200 01 5015E-A00200 03 5015E-A00200 04 5015E-A00200 07 5015E-A00200 21 5015E-A00200 22 5015E-A00200 24

### Covers for C-RC-0002R-Element



LCD1-Ti-white/ice white LCD1-Ti white/white LCD1-Ti-ice gray LCD1-Ti-caramel/ice gray LCD1-Ti-ivory/ice gray LCD1-Ti-agave/ice gray LCD1-Ti-carmine/ice gray LCD1-Ti-cofee/ice opal

### Covers for C-RI-0401R-Element



3902E-A00001-01-RI 3902E-A00001-03-RI 3902E-A00001-04-RI 3902E-A00001-07-RI 3902E-A00001-21-RI 3902E-A00001-22-RI 3902E-A00001-24-RI 3902E-A00001-25-RI

### Frames for Element



3901E-A00110 01 3901E-A00110 03 3901E-A00110 04 3901E-A00110 07 3901E-A00110 21 3901E-A00110 22 3901E-A00110 24 3901E-A00110 25

### End caps for Element



3902E-A00001-01 3902E-A00001-03 3902E-A00001-04 3902E-A00001-07 3902E-A00001-21 3902E-A00001-22 3902E-A00001-24 3902E-A00001-25

## CIB devices:



C-WS-0200R-Time  
TXN 133 30



C-WS-0400R-Time  
TXN 133 31



C-IT-0200R-ABB-Zak  
TXN 133 19



C-RC-0002R-Time  
TXN 133 33



C-RI-0401R-Time  
TXN 133 47.01  
TXN 133 47.02  
TXN 133 47.03

Type	DI	DO	AI	AO	Comm
<b>C-WS-0200R-Time</b>	2 buttons		2× temperature external		CIB
<b>C-WS-0400R-Time</b>	4 buttons		2× temperature external		CIB

## Basic features

- Wall switches with short press control. Each rocker has two buttons, one. In upper and one in lower half.
- Each button can be configured for any action. Number of presses or length of the press can be evaluated to distinguish different statements.
- Additionally for each switch the sequence of actions/commands can be assigned, e.g. simultaneously to close the blinds, switch lights on with the specific intensity level, switch on the TV etc.
- Wall switches have terminals for connection of up two external

temperature sensors, for example temperature of interior and floor temperature.

## Connection

- Wall switches have to be connected to CIB bus, which provides both communication and power supply of module.

## Use

- In interiors into standard installation boxes under plaster.
- Wall switches are compatible with frames and sockets of Time and Element designs by ABB and can be combined with them.
- Combination of frames and covers in other colors than standard (white/white) is necessary to order on request for special price.

## Connection example

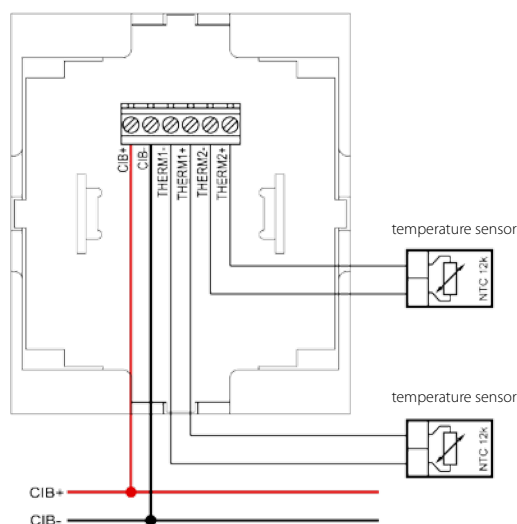

Analog inputs	C-WS-0200R	C-WS-0400R
<b>Input type</b>	2×NTC12k/ resistance 0–100 kΩ	2×NTC12k/ resistance 0–100 kΩ
<b>Range of measurement</b>	0..90 °C/0–100 kΩ	0..90 °C/0–100 kΩ
<b>Basic accuracy</b>	±1 °C	±1 °C

Digital inputs	C-WS-0200R	C-WS-0400R
<b>Input type</b>	2×built-in button	4×built-in button

## Operating conditions

<b>Operating temperature</b>	–10 .. +55 °C
<b>Storage temperature</b>	–25 .. +70 °C
<b>Electric strength</b>	according EN 60950
<b>IP Degree of protection (IEC 529)</b>	IP20
<b>Degree of pollution IEC EN60664-1:2008</b>	2
<b>Working position</b>	vertical
<b>Installation</b>	On installation box
<b>Connection, conductors cross-section</b>	screw terminals, 1,5 mm <sup>2</sup>

Dimensions and weight	C-WS-0200R	C-WS-0400R
<b>Dimensions</b>	83×81×21 mm	83×81×21 mm
<b>Weight</b>	60g	60g

Power supply	C-WS-0200R	C-WS-0400R
<b>Power supply and communication</b>	24 V (27 V) from bus CIB	24 V (27 V) from bus CIB
<b>Typical/max. load</b>	13 mA/17 mA	13 mA/17 mA
<b>Typical/max. input power</b>	0.3 W/0.4 W	0.3 W/0.4 W
<b>Internal protection</b>	No	No

## Order number

<b>TXN 133 30.01</b>	C-WS-0200R-Time; white/white, CIB, Controller with short-press control, 2 buttons
<b>TXN 133 31.01</b>	C-WS-0400R-Time; white/white, CIB, Controller with short-press control, 4 buttons
<b>TXN 133 30</b>	C-WS-0200R-ABB-Zak, CIB, Controller with short-press control, 2 buttons, frame and cover on request
<b>TXN 133 31</b>	C-WS-0400R-ABB-Zak, CIB, Controller with short-press control, 4 buttons, frame and cover on request

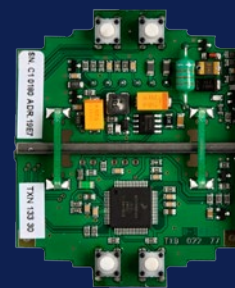

C-WS-0200R-ABB-Zak



C-WS-0400R-ABB-Zak



C-WS-0200R Time



C-WS-0400R Time

Requirements for other design of wall switches you can solve out with use of combined modules C-IT-0504S or C-IT-0908S.



# CIB – Group wall switch controllers Logus90 (EFAPEL)

Type	DI	RO	AI	AO	Comm
<b>C-WS-0200R-Logus</b>	2x button	1x LED green 1x LED red	1x internal temperature 2x external temperature		CIB
<b>C-WS-0400R-Logus</b>	4x button	2x LED green 2x LED red	1x internal temperature 2x external temperature		CIB

## Basic features

- Wall switches with short press button control. Each control element has up and down button.
- Each button may be configured in project SW for any meaning. E.g. we may evaluate length of press.
- Each button may be matched with sequence of commands, e.g. pull жалюзи, switch on the lights and set intensity of lights, switch on TV etc.
- Switches have led wires for connection of up to two external temperature sensors. E.g. interior temperature and floor temperature.
- Switches have built-in temperature sensors.

## Connection

- Wall switches are connected directly to CIB bus, which ensures communication and power supply of switches.

## Use

- For interiors into standard installation boxes under plaster.
- Switches are designed compatible with frames, devices and sockets LOGUS90 (Efapel) and may be free combined with them.
- Below mentioned order numbers mean only device, which need to be completed on order with switch cover and frame.

## Connection example

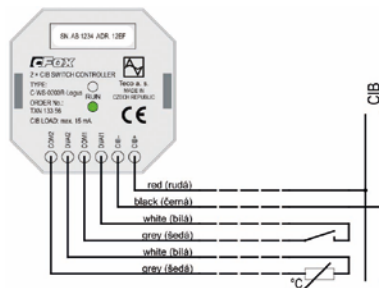

Button inputs	C-WS-0200R-Logus	C-WS-0400R-Logus
Input type	2x built-in button	4x built-in button

Binary outputs LED indication	C-WS-0200R-Logus	C-WS-0400R-Logus
Output type	1x green LED 1x red LED	2x green LED 2x red LED

Universal inputs	
Number of universal inputs	2x AI/DI
Galvanic isolation from CIB bus	No

Sensor type	Ranges	Základní Accuracy
Voltage-free contact	0/1	0 if >1.5 kΩ 1 if <0.5 kΩ
Balanced input (security systems)	Interrupted wire /0/1/tamper	for 2x 1k1 balanced resistor
Pt1000	-90 .. 320°C	0,5%
Ni1000	-60 .. 200°C	0,5%
NTC 12 k	-40 .. 125°C	0,5%
KTY81-121	-55 .. 125°C	0,5%
Resistor	0-160 kΩ	0,5%

Operating conditions	
Operating temperature	-10 .. +55 °C
Storage temperature	-30 .. +70 °C
Electric strength	according EN 60950
Electric device protection degree according EN 61140:2003	II
IP Degree of protection IEC 529	IPxxB
Overvoltage category	x
Degree of pollution according EN60664-1:2008	1
Operating position	Vertical
Installation	On the wall, into installation box
Connection, wire dimension	Independent wires, 0,5 mm <sup>2</sup>

Dimensions and weight	
Dimensions	88 x 86 x 38mm
Weight	79g

Power supply	
Power supply	24 V (27 V) from CIB bus
Nominal/max. load	13 mA/17 mA
Typ./Max. input power	0.3 W/0.4 W
Internal protection	No

Order number	
TXN 133 56	C-WS-0200R-Logus, CIB, Wall switch with short press control, 2 buttons, frame and cover on order
TXN 133 57	C-WS-0400R-Logus, CIB, Wall switch with short press control, 4 buttons, frame and cover on order

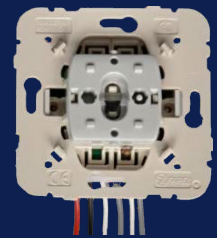

C-WS-0200R Logus

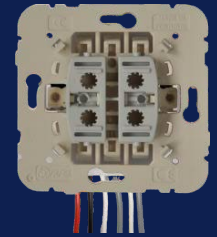

C-WS-0400R Logus



Bottom view



Switches must be completed with box and cover

## Basic features

- Because of wide range of color and material combinations of covers and frames in design line LOGUS90, it is necessary to order separately covers and frames as independent items.

## Order numbers

- Order numbers are mentioned bellow each image.

### Covers for C-WS-0200R-Logus



90601 TBR-U1  
White



90601 TMF-U1  
Ivory



90601 TGE-U1  
Ice



90601 TPE-U1  
Pearl



90601 TAL-U1  
Aluminium



90601 TIS-U1  
Gray

### Covers for C-WS-0400R-Logus



90611 TBR-U1  
White



90611 TMF-U1  
Ivory



90611 TGE-U1  
Ice



90611 TPE-U1  
Pearl



90611 TAL-U1  
Aluminium



90611 TIS-U1  
Gray

### Frames, line Basic

### Frames, line AQUA



90910 TBR  
White



90910 TMF  
Ivory



90910 TGE  
Ice



90910 TPE  
Pearl



90910 TAL  
Aluminium



90910 TIS  
Gray

### Frames, line Metallo



90910 TIA  
Inox, aluminium



90910 TOP  
Gold, aluminium



90910 TQS  
Nickel, gray



90910 TRS  
Chrome, gray



90910 TTP  
Titanium, pearl



90910 TUS  
Aluminium, gray

### Frames, line Arbore

### Frames, line Crystal



90910 TFP  
Beech, Pearl



90910 TJP  
Cherry-tree, pearl



90910 TMS  
Mahogany, gray



90910 TNA  
Walnut-tree,  
aluminium



90910 TCA  
Glass, aluminium



90910 TCG  
Glass, ice

### Frames, line Petra

### Frames, line Crystal



90910 TGA  
Granite, aluminium



90910 TGG  
Granite, ice



90910 TGP  
Granite, pearl



90910 TGS  
Granite, gray



90910 TCP  
Glass, pearl



90910 TCS  
Glass, gray

Type	DI	DO	AI	AO	Comm
<b>C-IT-0200R-Time</b>			2 x AI/DI		CIB
<b>C-IT-0200R-ABB Zak</b>			2 x AI/DI		CIB

## Basic features

- Module is on CIB bus connectable module designed for interior temperature measurement. The temperature is measured by sensor placed in the cover
- It is possible to connect second, external sensor, for example for floor temperature measurement, outside temperature etc.
- Modules of temperature measurement are available in different manufacturer designs. Availability of design please check at producer.
- Built in temperature sensor is placed in lower part of cover. This placement maximizes accuracy of measurement and eliminates influence of module heating to measurement.
- Input for external temperature sensor and connection CIB bus is placed in bottom part of module.
- Firmware supports linearization and direct reading of temperature from external NTC 5k, 10k, 12k, 15k and 20k. For these types of sensors it eliminates even distortion, resp. error of measurement for long distance.
- Input for external sensor can be used for measurement of general resistance up to 100 kΩ.
- Status and error/operation is indicated by LED diode at bottom part of module.

## Connection

- Module is used for assembly on the wall into standard installation box.
- Module has two parts: top part with sensor in interior design and bottom with electronics of connection into CIB bus and connection of external sensor.
- Upper and bottom part are connected each other with cable with connector.

## Use

- Module can be used for measurement of up to two temperatures. One interior and another external – for example outside temperature, floor temperature, etc.
- As external sensor we can connect also other resistance, for example photo resistance or potentiometer to set the value.

## Connection example

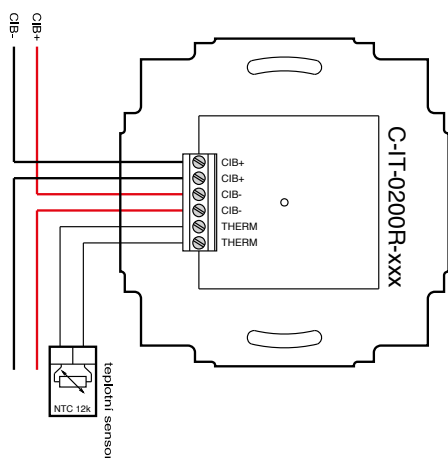

## Analog inputs

Sensor type	Range	Basic accuracy
Internal temperature	0 .. 55 °C	0.5 °C
External temperature (NTC 12k)	-20 .. +80 °C	0.5 °C

## Dimensions and weight

<b>Dimensions</b>	89 x 87 x 25 mm or according used design + 13 mm height of bottom part imbedded in a box
<b>Weight</b>	80 g

## Power supply

<b>Power supply and communication</b>	24 V (27 V) from bus CIB
<b>Nominal/max. load</b>	14.5 mA/17 mA
<b>Nominal/max. input power</b>	0.3 W/0.4 W
<b>Internal protection</b>	No

## Operating conditions

<b>Operating temperature</b>	0 .. +55 °C
<b>Storage temperature</b>	-25 .. +70 °C
<b>Electric strength</b>	according EN 60950
<b>IP Degree of protection (IEC 529)</b>	IP 10B
<b>Overvoltage category</b>	II
<b>Degree of pollution IEC EN60664-1:2004</b>	1
<b>Working position</b>	Vertical
<b>Installation</b>	Into installation box
<b>Connection of CIB, AI</b>	Screw terminals

## Order number

<b>TXN 133 19.01</b>	C-IT-0200R-Time; white/white, CIB, 2 x temperature (1 x internal, 1 x external)
<b>TXN 133 19</b>	C-IT-0200R-ABB Zak; CIB, 2 x temperature (1 x internal, 1 x external); cover and frame separately on request



C-IT-0200R-Time

Other designs on request



C-IT-0200R-Element



C-IT-0200R-Alpha



C-IT-0200R-Swing



C-IT-0200R-Tango

Designs ABB Solo, Future Linear, Impulse resp. others ask producer

Type	DI	DO	AI	AO	Comm
<b>C-IT-0200R-Design</b>			2 x Temperature internal, external		CIB

## Basic features

- Module is on CIB bus connectable module designed for measurement of temperature in interiors. Temperature is measured by sensor placed in cover.
- It is possible to connect second, external sensor for measurement of floor temperature, outside temperature etc.
- Modules of temperature measurement are available in designs of different manufacturers. Availability check at manufacturer.
- Built-in temperature sensor is placed in bottom part of cover. This placement maximizes accuracy of measurement and eliminates influence of module heating to measurement.
- Input for external temperature sensor and connection of CIB bus is placed in bottom built-in part of module.
- Firmware supports linearization and direct reading of temperature from external NTC 5k, 10k, 12k, 15k and 20k. For these types of sensors it eliminates even distortion, resp. error of measurement for long distance.
- Input for external sensor may be used also for measurement of general resistance up to 100 kΩ.
- Status is indicated by LED diode on bottom part of module.

## Connection

- Module is used for assembly on the wall into standard installation box.
- Module has two parts: upper with sensor in interior design and bottom with electronics of connection into CIB bus and connection of external sensor.
- CIB bus and inputs for external sensor connectable by isolated wires of length 70 mm with sleeves.
- Upper and bottom part are connected each other with cable with connector.

## Use

- Module can be used for measurement of up to two temperatures. One interior and another external – for example outside temperature, floor temperature, etc.
- As external sensor we may connect also other resistance, for example photo resistance or potentiometer to set the value.

## Connection example

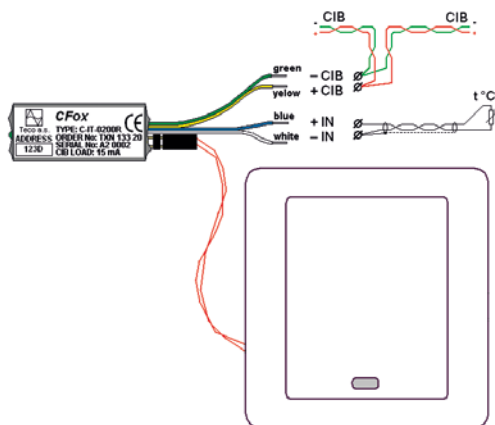

## Analog inputs

Sensor type	Range	Basic accuracy
Internal	0..+55 °C	0.5°C
External NTC 5k	0..90°C	0.5°C
External NTC 10k	0..90°C	0.5°C
External NTC 12k	0..90°C	0.5°C
External NTC 15k	0..90°C	0.5°C
External NTC 20k	0..90°C	0.5°C

## Operating conditions

Operating temperature	0 .. +55 °C
Storage temperature	-25 .. +70 °C
Electric strength	according EN 60950
IP Degree of protection(IEC 529)	IP 10B
Overvoltage category	II
Degree of pollution IEC EN60664-1:2004	1
Working position	any
Installation	Into installation box
Connection of CIB, AI	Tape wires with sleeves 1.15 mm <sup>2</sup>

## Analog inputs

Sensor type	Range	Basic accuracy
External resistance	0 – 25 kΩ	0.5 kΩ
External resistance	25 – 50 kΩ	0.5 kΩ
External resistance	50 – 100 kΩ	1 kΩ

## Dimensions and weight

Dimensions	56 × 26 × 16 mm (bottom part), upper part according used design
Weight	80 g

## Power supply

Power supply and communication	24 V (27 V) from CIB bus
Nominal load	45 mA
Nominal/max. input power	0.3 W/0.4 W
Internal protection	Return fuse

## Order number

TXN 133 20 C-IT-0200R-Zak; CIB, 2 x temperature (1 x internal, 1 x external); cover and frame separately on request

Example:  
C-IT-0200R – Legrand Galena



Other designs for individual order:



C-IT-0200R-Legrand Valena



C-IT-0200R-Legrand Cariva



C-IT-0200R-Niko Pure

C-IT-0200R-Schneider Unica

Designs LOGUS, DECENTE, ELEGANT, Jung, Berker, Gira, Merten and others please, ask producer

Type	DI	DO	AI	AO	Comm
<b>C-RI-0401R-Time</b>			1 × internal temperature 1 × external temperature/contact 1 × light sensor		CIB, IR both directions

## Basic features

- Module with bidirectional infrared interface with interior design for use with majority of remote controllers. Module has also inputs for light intensity sensor, temperature sensor and external temperature sensor or contact.
- This input can be used also as balanced input for connection of security detectors.
- Standard design is Time (ABB) white/white.
- Other designs may be delivered on request after agreement with manufacturer.
- Module may learn IR commands of remote controllers of different devices: air-conditioning units, audio/video etc. – and store them in module memory. Subsequently, these commands can be transmitted by a command from the system over CIB bus.
- By this the manual control can be replaced by automatic control of central module.

## Connection example

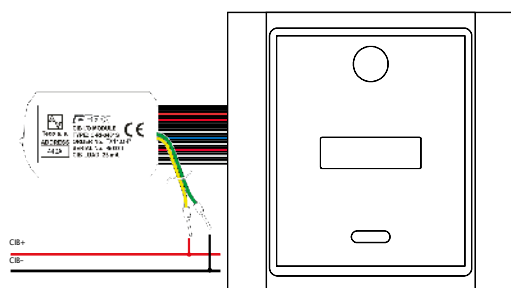

## IR receiver

Number of inputs	1 × demodulator
Galvanic isolation	No
Power supply of receiver – demodulator	3.3 V
Pilot frequency of demodulator	36 kHz

## IR transmitter

Number of outputs	1
Galvanic isolation	No
Type of IR transmitter	IR LED (I <sub>max</sub> = 100 mA) + resistor according IF
Power supply of transmitter	3.3 V
Short-circuit protection	No

## Input for light sensor

Number of inputs	1
Galvanic isolation	No
Sensor type/range/input error	Photodiode 0 – 50 000 lx / < 5%

## Operating conditions

Operating temperature	–10 .. +55 °C
Storage temperature	–25 .. +70 °C
Electric strength	according EN 60730
IP Degree of protection (IEC 529)	IP 10B
Overvoltage category	II
Degree of pollution IEC EN60664-1:2008	1
Working position	any
Installation	on installation box, in interior
Connection of CIB, AI/DI,	flat cable 0.5 mm <sup>2</sup>

## Order number

TXN 133 47.01	C-RI-0401R-Time, white/white, CIB combined module for 1 × IR transmitter, 1 × IR receiver-demodulator, 1 × light, 1 × temperature, 1 × external input
TXN 133 47.xx	C-RI-0401R-Zak, on request manufacture: design, frame and cover on order, 1 × IR transmitter, 1 × IR receiver-demodulator, 1 × light, 1 × temperature, 1 × external universal input. Other combination of sensors on order.

## Connection

- Module has to be connected to CIB bus, which provides both communication and power supply of module.
- CIB bus is available on 2 wires. Other signals are available on belt cable fixed on connector. Each wire is finished by pressed sleeve.
- Module is used for assembly to standard installation box under plaster similar like other wall switches or sockets.

## Use

- Integration of devices remotely controlled via infrared controllers, e.g.:
  - Interior air-condition units,
  - Audio, video
  - Consumer electronics with IR controller
- In system we can define own actions and sequences, that can be assigned to commands from remote controller and expand the possibilities of present remote control to any IR controlled device.
- Measurement and subsequently control of lights in interior.

## Analog/combined inputs

Number of inputs	1 × AI/DI, 1 × temperature
Galvanic isolation	No
Resolution	12 bit

## Measurement ranges

Sensor type	Range
Potential free contact	switched on/ switched off
Balanced input (security systems)	broken line/0/1/ tamper
Pt1000	–90 .. 320 °C
Ni1000	–60 .. 200 °C
NTC 12k	–40 .. 125 °C
KTY81-121	–55 .. 125 °
Resistance	0 – 160 kΩ
Analog input error	< 2 %

## Dimensions and weight

Dimensions	83 × 81 × 17 mm
Weight	70 g

## Power supply

Power supply and communication	24 V (27 V) from bus CIB
Nominal load	25 mA
Maximal input power	0.5 W
Internal protection	No



C-RI-0401R-Time



# CIB – wall device with LCD for measurement and temperature setting

Type	DI	DO	AI	AO	Comm
<b>C-RC-0002R-Time</b>	3 x button		2 x temperature internal, external		CIB LCD display
<b>C-RC-0002R-Design</b>					

## Basic features

- Module is designated into interiors as the most simple variant for measuring and visualization of current temperature as well as for setting the new temperature set-point.
- Function of module is given by the user program. Module can be used also for other tasks, if the combination of inputs and outputs is usefull.
- 3 digits LCD display with 7 segment digits.
- 2 buttons with a symbol of arrows enable to set the correction of required temperature – increase, decrease.
- 1 button and LED indicator – designed to set and indicate standard or comfortable mode.
- Built-in temperature sensor placed in lower part of front panel. This position maximizes accuracy of measurement and eliminates influence of module heating to measurement.
- Input for external temperature sensor and connection of CIB bus are available on stranded wires of the rear part of module.

- Module is available in ABB Time design as standard. The other designs are available on request after confirmation of the manufacturer.
- Firmware of the module supports linearization and direct reading of temperature from external NTC 5k, 10k, 12k, 15k and 20k. For these types of sensors it eliminates also distortion, resp. error of measurement for long distance.
- Input for external sensor can be used for measurement of any resistance up to 100 kΩ.
- Status is indicated by LED diode on the rear part of module.

## Connection

- Module is used for assembly on the wall into standard installation box.
- Module has two parts: upper one with interior design with control elements and temperature sensor and rear one with electronics of CIB bus and with inputs of external sensor.
- CIB bus and input for external sensor are available on isolated wires of length 70 mm finished by pressed sleeves.
- Upper and rear part are connected with flat cable with connector.

## Use

- Module can be used for setting of required temperature or other values with present visualization of value at 3 digits LCD display.
- Module can be used for measurement up to 2 temperatures. One internal and one external – for example outside temperature, floor temperature etc.
- As external sensor also other resistance, for example photo resistance or potentiometer to set the value can be used.

## Connection example

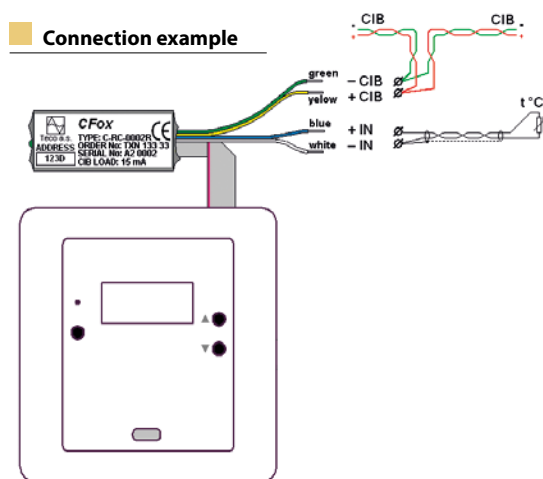

## Analog inputs

Sensor type	Range	Basic accuracy
Internal temperature	0..+55 °C	0.5 °C
External NTC 5k	0..90 °C	0.5 °C
External NTC 10k	0..90 °C	0.5 °C
External NTC 12k	0..90 °C	0.5 °C
External NTC 15k	0..90 °C	0.5 °C
External NTC 20k	0..90 °C	0.5 °C

## Analog inputs

Sensor type	Range	Basic accuracy
Resistance	0 – 25 kΩ	0.5 kΩ
Resistance	25 – 50 kΩ	0.5 kΩ
Resistance	50 – 100 kΩ	1 kΩ

## Operating conditions

Operating temperature	0 .. +55 °C
Storage temperature	-25 .. +70 °C
Electric strength	according EN 60950
IP Degree of protection (IEC 529)	IP 10B
Overvoltage category	II
Degree of pollution IEC EN60664-1:2008	1
Working position	any
Installation	into installation box
Connection of CIB, AI	isolated wires with pressed sleeves 0.15/0.5 mm <sup>2</sup>

## Dimensions and weight

Dimensions	83 x 81 x 25 mm
Weight	80 g

## Power supply

Power supply and communication	24 V (27 V) from bus CIB
Typical load	45 mA
Typical input power	0.3 W, /0,4 W
Internal protection	Return fuse

## Order number

TXN 133 33.01	C-RC-0002R-Time, white/white, CIB, Controller with LCD, measurement and setting of temperature
TXN 133 33	C-RC-0002R-Zak., CIB, Controller with LCD, measurement and setting of temperature (design, color on request)



C-RC-0002R-Time

Designs on request:



C-RC-0002R-Berker



C-RC-0002R-Bticino



C-RC-0002R-Legrand



C-RC-0002R-Unica



C-RC-0002R-Niko

Designs LOGUS, DECENTE, ELEGANT, Jung, Berker, Gira, Merten and others ask producer

Type	DI	RO	AI	AO	Comm
<b>RCM2-01</b>		1	2		CIB

## Basic features

- Device is designed as an interior device for monitoring and setting the required temperature and other values as a Room Control Manager.
- It has the LCD to display one value – temperature, (or time, humidity, velocity etc.) and the amount of graphic icons frequently used for heating, ventilation and air-conditioning (HVAC).
- Moving through the menu and settings are performed by rotary element with the pushbutton for acknowledgement.
- Built-in temperature sensor. The additional temperature sensor can be connected. It can be placed on most suitable place in the room.
- The device is fully free programmable through the Mosaic. Programmer can control any icon as a binary output and the displayed number as numerical value. The unit will give the information about the rotation and click on pushbutton.

## Connecting

- The device is connected by two wires of CIB, which provide both power supply and communication channel.
- The device is for mounting on the wall on the flush box.

## Use

- As a Room Control Manager to each room or space where individual control of temperature and air ventilation is required.

## Connection example

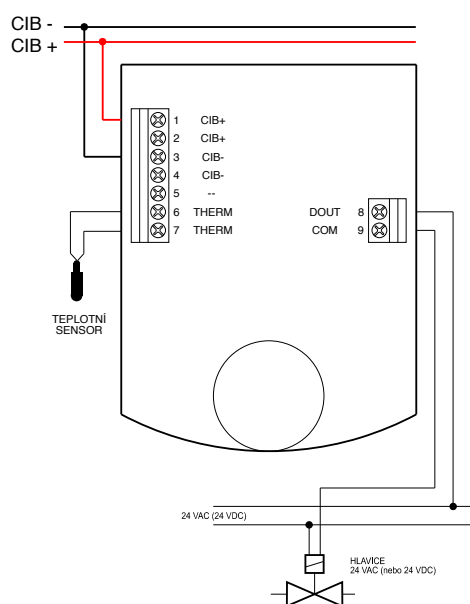

## Specification

<b>Display</b>	LCD, value (temperature, time) + graphical symbols (heating, ventilation, etc.)
<b>Control element</b>	Knob with button (choice of mode, correction of temperature etc.)
<b>Inputs</b>	2 x measurement of temperature (internal and external sensor)
<b>Measured temperature range</b>	-20 ÷ +100 °C
<b>Measurement accuracy</b>	±0.8 °C
<b>Output</b>	1 x SSR
<b>Type</b>	Independent contact
<b>Galvanic isolation</b>	yes, 1500 V
<b>Nominal voltage</b>	24 V AC/DC
<b>Max. voltage</b>	60 V AC/DC
<b>Max. current</b>	600 mA
<b>Communication/Power supply</b>	Bus CIB/24 V (27 V)
<b>Load from CIB</b>	17 mA
<b>Mechanical construction</b>	Plastic module on wall
<b>Dimensions of module (š x v x h)</b>	90 x 115 x 39 mm
<b>Weight</b>	130 g
<b>Operational temperature</b>	0 ÷ +55 °C
<b>Storage temperature</b>	-30 ÷ +70 °C
<b>Electric strength</b>	according EN 60950
<b>IP Degree of protection IEC 529</b>	IP 20
<b>Overvoltage category</b>	II
<b>Degree of pollution IEC EN 60664-1:2004</b>	1
<b>Working position</b>	Vertical (button down)
<b>Installation</b>	On wall, on installation box
<b>Connection</b>	screw terminals
<b>Conductors cross-section</b>	max. 1.5 mm <sup>2</sup>



RCM2-01



RCM2-01

## Order number

TXN 131 57 RCM2-1, CIB, interior room control unit

Type	DI	DO	AI	AO	Comm
<b>C-AQ-0001R</b>			1 x CO <sub>2</sub> , 1 x temperature		CIB
<b>C-AQ-0002R</b>			1 x gas, 1 x temperature		CIB
<b>C-AQ-0003R</b>			1 x smoke, 1 x temperature		CIB
<b>C-AQ-0004R</b>			1 x humidity, 1 x temperature		CIB



C-AQ-0001R

Interior room sensors of air quality are used for control of ventilation, recuperation, air-condition. In case the air exchange in room is controlled according to sensors only for necessary time, it is possible to reach significant energy savings, especially with connection of recuperation.

## C-AQ-0001R – Room sensor of carbon dioxide (CO<sub>2</sub>)

### Basic features

- Two channel measuring optical system on principle NDIR.
- High selectivity on carbon dioxide in concentration range 0 ÷ 5000 ppm CO<sub>2</sub>.
- Measurement CO<sub>2</sub> uses dependence of infrared radiation attenuation on CO<sub>2</sub> concentration in the air. The change of attenuation is converted to value transmitted into system via CIB.
- Auto diagnostic of correct function.
- Long service life and stability, typically 10 years.
- Built-in dust filter.
- Easy installation on the wall.

### Connection

- The device is connected by two wires of CIB, which provide both power supply and communication channel.

### Use

- Concentration of CO<sub>2</sub> is very good relevant to the stale air in closed space. It corresponds very good with number of people in enclosure room. That's why it is suitable for:
  - Systems of air-quality check.
  - Controlled ventilation in offices, cinemas, hotels, hospitals, gym halls, schools etc.
  - Control the recuperation in low-energy buildings.
  - Greenhouses, mushroom growing facilities, storage of fruit.
  - Breeding companies, where is a high concentration of animals.
  - Monitoring and control of food processes – fermentation, maturation.

### Specification

Measuring range	0 ÷ 5000 ppm
Start of sensor after switch on	2 min
Resolution	1 ppm
Accuracy	50 ppm ± 5% from value
Repeatability	10 ppm ± 1% from value
Long time stability	± 50 ppm/year
Air pressure influence	1.6%/kPa
Operation humidity	Max. 95% noncondensing
Calibration	From manufacturer
Lifetime	Typically 10 years
Power supply and communication	24 V (27 V) from CIB bus
Load from CIB	Typ. 90 mA

## C-AQ-0002R – Room sensor of gaseous and volatile pollutants (VOC – Volatile Organic Compounds)

### Basic features

- High sensitivity on gaseous pollutants in the air – volatile organic compounds, especially toluene, hydrogen sulfide, ethanol, hydrogen, ammonia
- Other detectable pollutants alcohol vapors, methane, propane-butane, natural gas leakage, pollutants evaporating from inside equipment of buildings.
- Measurement is based on electrochemical principle of measuring selective semiconductor sensor conductivity of air pollution.
- Conductivity is converted into numeric value and transferred further into system via CIB bus.
- Good long time stability.
- Easy mounting on the wall.

### Connection

- The device is connected by two wires of CIB, which provide both power supply and communication channel.

### Use

- For control of ventilation systems on demand (DCV – demand controlled ventilation).
- Control of ventilation for restaurants, hotels, offices, kitchens, households, etc.
- Systems of air quality monitoring..



C-AQ-0002R

### Specification

Measuring range	0 ÷ 5 ppm, 0 ÷ 50 ppm optional
Start of sensor after switch on	10 min
Operating temperature	0 ÷ 40 °C
Power supply and communication	24 V (27 V) from bus CIB
Load from CIB bus	Typ. 80 mA

## C-AQ-0003R Room sensor of tobacco smoke and other gaseous air pollutants

### Basic features

- High sensitivity on gaseous pollutants in the air, especially on cigarette smoke (carbon monoxide CO and hydrogen H).
- Orientation detection of leakage: methane gas, propane, natural gas.
- Measurement of pollutants is based on electrochemical principle of measuring the conductivity of the semiconductor sensor of air contamination. The conductivity is directly converted to a numerical value transmitted further into the system through the CIB.
- Good long time stability.
- Easy mounting on the wall.

### Connection

- The device is connected by two wires of CIB, which provide both power supply and communication channel.

### Use

- For control of ventilation systems (DCV – demand controlled ventilation)
- Control of ventilation for restaurants, hotels, offices, kitchens, households, etc.
- Systems of air quality monitoring.



C-AQ-0003R

### Specification

Measuring range	0 ÷ 5 ppm, 0 ÷ 50 ppm optional
Start of sensor after switch on	10 min
Operating temperature	0 ÷ 40 °C
Power supply and communication	24 V (27 V) from CIB bus
Load from CIB bus	Typ. 80 mA

## C-AQ-0004R Room sensor of relative humidity, temperature and dew point

### Basic features

- C-AQ-0004R is an electronic sensor of relative humidity with capacitive polymer sensor. The sensor is designed as standard system peripheral of Foxtrot system with connection into CIB bus, which provides both communication and power supply of sensor.
- Long time stability.
- Fully calibrated.
- Transfer values of relative humidity, room temperature and dew point.

### Use

- Ventilation systems in interiors.
- Measurement and regulation of relative humidity in industry, storage, historic buildings, archives.
- Air-condition and recuperation units.



C-AQ-0004R

### Connection example

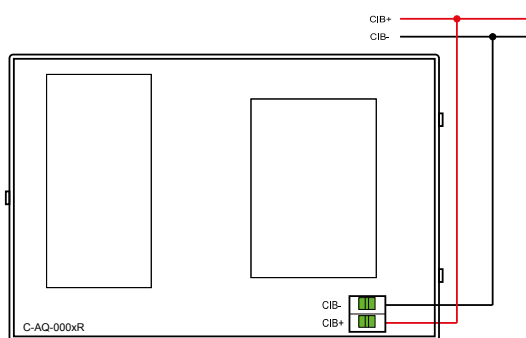

### Specification

Measuring range	0 ÷ 100% RH
Resolution	0.1% RH
Accuracy	±3.5% RH (in range 20 ÷ 80%) ±5% RH (in range 0 ÷ 100%)

### Operating conditions

Operating temperature	0 ÷ +40 °C
Storage temperature	-20 ÷ +60 °C
Electric strength	according EN 60950
IP Degree of protection IEC 529	IP 20
Overvoltage category	2
Degree of pollution IEC EN 60664-1:2004	1
Working position	any
Installation	on wall
Connection	screw terminals
Conductors cross-section	max. 2.5 mm <sup>2</sup>

### Dimensions and weight

Dimensions	125 × 83 × 36 mm
Weight	300 g

### Power supply

Power supply and communication	24 V (27 V) from bus CIB
Load from CIB bus	Typ. 25 mA

### Order number

TXN 133 12	C-AQ-0001R, Room sensor of concentration CO <sub>2</sub>
TXN 133 13	C-AQ-0002R, Room sensor of gaseous pollutants (VOC)
TXN 133 14	C-AQ-0003R, Room sensor of air pollutants (smoke detector)
TXN 133 15	C-AQ-0004R, Room sensor of relative humidity in air

# CIB – Proportional drive of radiator valve

Type	DI	DO	AI	AO	Comm
<b>C-HC-0201F-E</b>			2 × AI/DI	valve position 0 – 100%	CIB
<b>C-HC-0101F</b>			1 × AI	valve position 0 – 100%	CIB

## Basic features

- Motor drive actuator for the radiator valve.
- Universal input/output for external sensors can be configured as analog or digital. So both temperature sensor or window contact can be connected to C-HC-0201F-E.
- Firmware of the module linearizes characteristics of temperature sensor, optimizes accuracy of measuring and recalculates it to temperature, which is further transferred into central module. Module C-HC-0101F has very low consumption!

## Connection

- Drive is connected to the CIB bus which provides both communication and power supply for the drive, including the motor.
- External sensors are connected via screw terminals.

## Use

- For individual zone heating control.
- To control radiator valves or valve for floor heating.
- Direct fixing at radiator actuator or floor distributor with thread M30×1.5 or reduction.

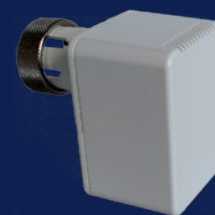

C-HC-0201F-E

## Connection example

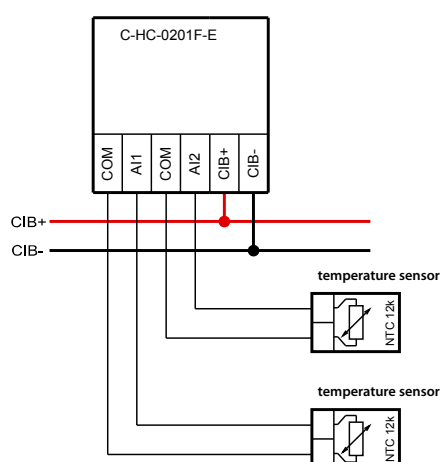

C-HC-0101F preliminary

Analog/combined inputs	C-HC-0201F-E	C-HC-0101F
Number of inputs	2	1
For sensors	NTC 12k/Pt1000/Ni1000/0 – 100 kΩ	NTC 12k/resistance 0 – 100 kΩ
Measuring range	0..90 °C/0 – 100 kΩ	0..90°C/0 – 100 kΩ

## Valve drive

Drive type	proportional (0-100 %)
Drive stroke	typ. 1.5 mm (max. 2.7 mm)
Drive running time 0 -> 100 %	cca. 30 s
Drive adjustment	automatic + manual
Automatic valve rotation	yes, 30 days period

## Operating conditions

Operating temperature	-10 .. +55 °C
Storage temperature	-25 .. +70 °C
Electric strength	according EN 60730
IP Degree of protection (IEC 529)	IP20
Overvoltage category	II
Degree of pollution according IEC EN60664-1:2008	1
Working position	Any
Installation	Fixing on radiator actuator M30×1.5 mm, or with reduction
Connection CIB	Push-in terminals 0.14 ÷ 1.5 mm²

## Dimensions and weight

	C-HC-0201F-E	C-HC-0101F
Dimensions	69 × 48 × 73 mm	75 × 85 × 50 mm
Weight	125 g	125 g

## Power supply

	C-HC-0201F-E	C-HC-0101F
Power supply and communication	24 V (27 V) from bus CIB	24 V (27 V) from bus CIB
Typical/max. load	5 mA/80 mA	15 mA/17 mA
Typical/max. input power	2.4 W	0.3 W/0.4 W
Internal protection	No	No

## Order number

TXN 133 48	C-HC-0201F-E, CIB, Valve 2 × AI/DI Temperature/contact, 1 × proportional (0 – 100%) drive of thermostatic actuator
TXN 133 28	C-HC-0101F, CIB, Valve 1 × AI Temperature/contact, 1 × proportional (0 – 100%) drive of thermostatic actuator
	Reduction of the valve on order



**Wireless communication RFox is:**

- **Both directional**
  - **With confirmation**
  - **With mesh technology**
  - **With low input power**
- 
- Company Teco comes with extension of peripherals line of Foxtrot system with wireless communication with inputs/outputs modules.
  - In such way Foxtrot becomes even more universal, because it can combine classic PLC peripherals, installation via two wires CIB bus and now also wireless installation RFox in any ratio.
  - There is the possibility to create only wireless network with central control.
  - Configuration of the wireless network is integrated in development software Mosaic.
  - To extend the Foxtrot system by the wireless network, RFox master RF-1131 module has to be placed on TCL2 system bus. Each wireless module has to be bonded to its master and then placed at its final operation place.
  - In first group of wireless modules are key ring, wall switches, interior wall controller (Room Control Manager), module with 4 voltage-free inputs, module with 1 relay and drive of the radiator valve.

# RFox

Intelligent wireless electroinstallation and measurement at 868MHz frequency band

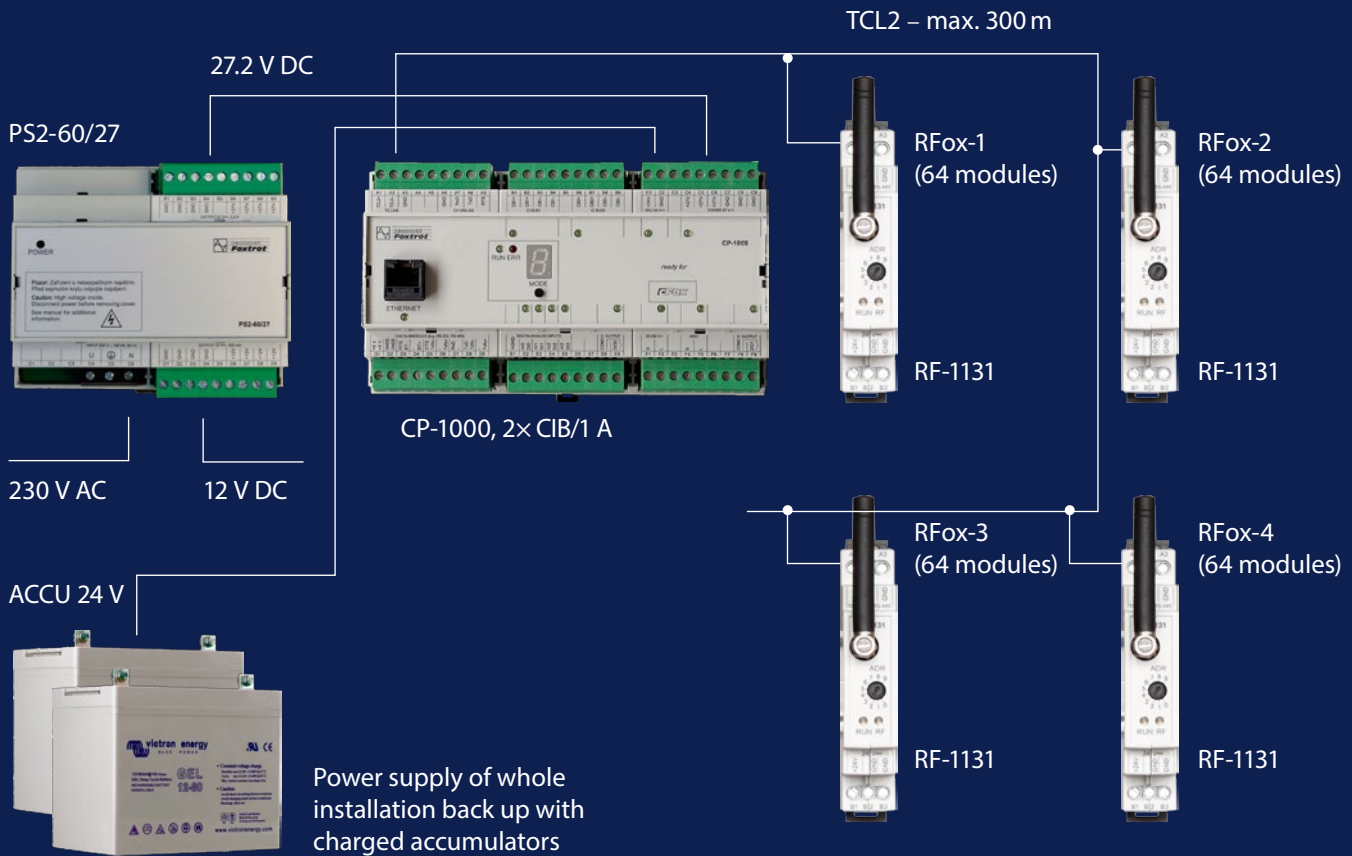

## Interior modules



R-WS-0200R  
Wall switch  
2 buttons



R-WS-0400R  
Wall switch  
4 buttons



R-IT-0100R  
Wall temperature  
sensor



R-RC-0002R  
Universal wall  
sensor

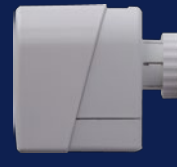

R-HC-0101F  
Radiator  
actuator drive



R-KF-0400T,  
R-KF-0500T  
Key rings  
R-RT-2305 W Router

## Portable modules

## Modules into switchboards



R-HM-1113M  
Combined module  
on DIN rail



R-HM-1121M  
Combined module  
on DIN rail

## Built-in modules



R-OR-0001B  
1x Relay 230 V AC



R-IB-0400B  
4x contact sensor

## Modules with protection IP65

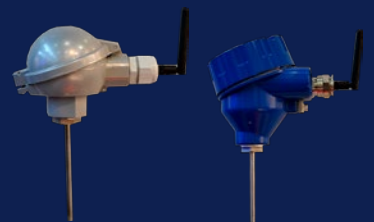

R-IT-0100I-A  
Temperature sensor

## RFox master

Type	DI	DO	AI	AO	Comm
<b>RF-1131</b>					TCL2, RFox

### Basic features

- Module is the gateway of Foxtrot system into the wireless data network RFox. Module is the master of bidirectional communication with the slaves with confirmation of each data transmission. It operates in the licence free frequency band 868 MHz.
- As coordinator/master of data network RFox module enables to connect up to 64 wireless modules with inputs and outputs to Foxtrot system.
- Module RF-1131 is not included in the limit of max. 10 modules on TCL2 bus.
- Module is operated on low power up to 10mW.
- Master module continuously monitors the network to keep the actual status of all slaves. This status image is available for central module anytime. Vice versa the master module fulfills commands of central module and writes new statuses into slave modules.

### Connection

- Module is designed as standard communication module at TCL2 bus.
- Mechanical design is suitable for installation on DIN rail.
- Antenna or cable can be connected on module directly with SMA connector.

### Use

- Creation of wireless control system with centralised processing of signals and commands.
- Creation of wireless and wire system combination.
- Suitable for reconstruction of buildings in places, where we cannot install the electrical installation bus.
- For any application, where digital or analog values needs to be wireless transferred.



RF-1131

### Connection example

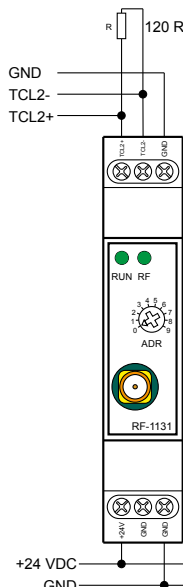

### Communication

<b>System I/O bus</b>	1 x TCL2 (RS-485, 345 kbit/s) up to distance 300 m, without branches, impedance terminating 120 Ω
<b>Wireless communication</b>	RFox
<b>Frequency</b>	868.35 MHz
<b>Signal transfer</b>	Both directions, with confirmation, with routing
<b>Range</b>	About 25 m in building, 100 m in free space

### Operating conditions

<b>Operating temperature</b>	-20 ÷ +55 °C
<b>Storage temperature</b>	-30 ÷ +70 °C
<b>Electric strength</b>	according EN 60950
<b>IP Degree of protection IEC 529</b>	IP 10B
<b>Overvoltage category</b>	III
<b>Degree of pollution IEC EN 60664-1:2004</b>	2
<b>Working position</b>	Any
<b>Installation</b>	on DIN rail
<b>Connection</b>	screw terminals, Antenna – SMA connector
<b>Conductors cross-section</b>	max. 2.5 mm <sup>2</sup>

### Dimensions and weight

<b>Dimensions</b>	90 x 18 x 65 mm
<b>Weight</b>	75 g

### Power supply

<b>Power supply voltage (SELV)</b>	+24 V DC/30 mA
<b>Allowed range</b>	-15% +25% (20.4 ÷ 30 V DC)
<b>Max. input power</b>	2.5 W
<b>Galvanic isolation</b>	No

### Order number

<b>TXN 111 31</b>	RF-1131, RFox – Communication module, Master of wireless network
-------------------	--

# RFox – wireless wall switches and sensors Time, Element (ABB)

Type	DI	DO	AI	AO	Comm
<b>R-WS-0200R-Time</b>	2				RFox
<b>R-WS-0400R-Time</b>	4				RFox
<b>R-IT-0100R-Time</b>			1 temperature		RFox

## Basic features

- Wall group switches with short-press control. Each control element has button in upper and lower part.
- Each pushbutton can be configured for any action during project realization. The length of pressing of each button can be evaluated as single command to multiply functionality of the device. Under one command can be configured more simultaneous actions - scenarios like closing the blinds, lights on for preset intensity, the TV on etc.
- Power supply comes from built-in, exchangeable battery.

## Connection

- Controller has no external connection.
- Into RFox network it is connected by process of bonding.

## Use

- In interiors into standard installation boxes under plaster, stick on flat surface or free use as portable device.
- Controllers are designed to be compatible with frames and devices of ABB design Time and Element. Basic color design of frames and button covers is white/white.
- Frames and covers in other colors can be ordered/delivered on request.



R-WS-0400R Time



R-WS-0200R Time



R-IT-0100R-Time

Digital inputs	R-WS-0200R	R-WS-0400R	Analog inputs	R-IT-0100R
Input type	2 x Button	4 x Button	Input type	1 x temperature

Communication	R-WS-0200R	R-WS-0400R	R-IT-0100R
Wireless bus	RFox	RFox	RFox
Antenna	Integrated	Integrated	Integrated
Frequency	868 MHz	868 MHz	868 MHz
Signal transfer	Both directions with confirmation	Both directions with confirmation	Both directions with confirmation
Range	About 25 m in building, 100 m in empty space	About 25 m in building, 100 m in empty space	About 25 m in building, 100 m in empty space
Interval of transmitting	7 min (without input activation), always during activation	7 min (without input activation), always during activation	7 min (without input activation), always during activation

Dimensions and weight	R-WS-0200R	R-WS-0400R	R-IT-0100R
Dimensions	83×81×19mm	83×81×19mm	83×81×19mm
Weight	70g	70g	70g

Power supply	R-WS-0200R	R-WS-0400R	R-IT-0100R
Power supply and communication	CR2032 lithium battery	CR2032 lithium battery	CR2032 lithium battery
Lifetime of battery	Min.t 1 year according frequency of usage.	Min. 1 year according frequency of usage.	Min. 1 year according frequency of usage.

Operating conditions	
Operating temperature	-20 .. +55 °C
Storage temperature	-30 .. +70 °C
IP Degree of protection IEC 529	IP 20
Working position	Any. According position may change communication abilities.
Installation	On installation box or flat surface

## Order number

<b>TXN 132 30</b>	R-WS-0200R-Time, Element, RFox, wall switch with 2 short press buttons
<b>TXN 132 31</b>	R-WS-0400R-Time, Element, RFox, wall switch with 4 short press buttons
<b>TXN 132 32</b>	R-IT-0100R-Time, Element, RFox, Temperature sensor in interior design.

Important notice! To complete wall switches it is necessary to order separately the cover and the frame in required color according to product line ABB Time/Element! See chapter Covers and frames in Price list or at web page.

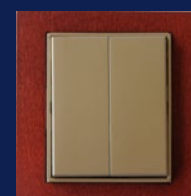

R-WS-0400R Time-Arbo



R-WS-0400R-Time-Champagne

## Room Control Manager

Type	DI	DO	AI	AO	Comm
<b>R-RC-0001R</b>			2		RFox

### Basic features

- Wireless module in interior design for offices and residential facilities. Module is designed for visualization of status and setting required values (Room Control Manager).
- LCD display displays the values (temperature, time, humidity, speed, heating, cooling, ... see image) and a lot of graphic icons often used on field of heating, ventilation and air-condition.
- Rotational element with pushbutton for confirmation is available to program individual needs of movement over the menu.
- Built-in temperature sensor. Also possibility to connect external NTC sensor to choose suitable place of measuring, independent on device position.
- Module is free programmable by user. Any icon or number can be controlled as digital output. The operations of rotational element and its pushbutton are accessible to programmer.

### Connection example

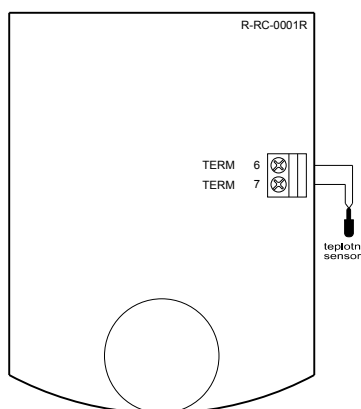

### Operating conditions

Operation temperature	0 ÷ +55 °C
Storage temperature	-30 ÷ +70 °C
Electric strength	according EN 60950
IP Degree of protection IEC 529	IP 20
Overvoltage category	II
Degree of pollution IEC EN 60664-1:2004	1
Working position	Vertical
Installation	On wall, on installation box

### Order number

TXN 132 09 R-RC-0001R, RFox, interior room unit

### Connection

- Module is designed as standard device of data radio network RFox. Power supply comes from battery.

### Use

- Use as Room Control Manager in each room or space, where we require individual control of temperature and ventilation.



R-RC-0001R

### Display and control elements

Display	LCD, value (temperature, time) + graphic symbols (heating, ventilation, ...) Each icon is controlled from program in central module
Control element	Knob with push button (mode selection, temperature correction, etc.) Rotation and push can be processed in user program

### Analog inputs

Inputs	2 x temperature measuring (internal sensor and external sensor NTC 12k)
Range of measured temperature	-20 ÷ 100 °C
Measurement accuracy	±0.8 °C
Interval of measured temperature	10 min

### Communication RFox

Frequency	868 MHz
Signal transmission	Both directions with confirmation
Range	About 25 m in building, 100 m in empty space
Interval of transmission	10 min

### Dimensions and weight

Mechanical construction	Plastic box on wall
Dimensions	90 x 115 x 39 mm
Weight	130 g

### Power supply

Power supply	AA lithium battery, 3,6 V /2,2Ah, ER14505M
Battery lifetime	About 2 years (according to frequency of using)



Type	DI	DO	AI	AO	Comm
<b>R-HC-0101F</b>			1	0 – 100% valve position	RFox



R-HC-0101F

## Basic features

- Motor control of head on radiator valve.
- Contains internal sensor of room temperature.

## Connection

- Head mount on radiator valve only.
- It has no wire connection.
- Into RFox network module is connected by bonding process.

## Use

- Regulation of hot water heating in rooms – radiator or floor.
- Direct fixing on radiator valve M30×1.5 or via reduction.

## Connection example

## Communication

Wireless bus	RFox
Antenna	Integrated
Frequency	868 MHz
Signal transmission	Both directions with confirmation
Range	About 25 m in building, 100 m in empty space
Range of temperature and position measuring and transmitting	7 min

## Inputs

Input/measured value	1 × temperature sensor
Range of measured temperature	-5 °C ÷ +50 °C
Basic measuring accuracy	+/-0.8 °C
Calibration	From manufacturing

## Outputs

Output value	Opening valve 0 – 100%
--------------	------------------------

## Dimensions and weight

Dimensions	75 × 85 × 50 mm
Weight	120 g

## Power supply

Power supply	1 × or 2 × AA lithium battery
Battery lifetime	Min. 1 year
Diagnosis battery	Yes

## Operating conditions

Operation temperature	0 ÷ +55 °C
Temperature of storage and transport	-25 ÷ +70 °C
Relative humidity	< 80 %
IP Degree of protection according IEC 529	IP 20
Degree of pollution	1
Installation	Plastic head, fixing to radiator valve M30 × 1.5 mm or with reduction

## Order number

TXN 132 28 R-HC-0101F, RF, Proportional drive of radiator valve (0 – 100%), 1 × AI, Reduction on valve on order

Type	DI	DO	AI	AO	Comm
<b>R-KF-0500T</b>	5				RFox
<b>R-KF-0400T</b>	4				RFox



R-KF-0500T



R-KF-0400T

## R-KF-0500T, R-KF-0400T – key rings

### Basic features

- Portable personal controller in shape of key rings.
- Equipped with 5 resp. 4 buttons, its functions or commands sequence is free programmable from the system.
- Battery status monitoring.

### Connection

- Key ring is portable, wireless connectable into data radio network RFox.

### Use

- Personal controller for entering 5 or 4 different user pre-programmed commands into RFox network.

Communication	R-KF-0500T R-KF-0400T
Frequency	868 MHz
Signal transmission	Both directions with confirmation
Range	About 30m in building, 100m in empty space <sup>1)</sup> <sup>1)</sup> range very depends at kind of building construction materials and way of installation. To extend the range of communication the routing technology is available.

Digital inputs	R-KF-0500T R-KF-0400T
Number of inputs	5 × button 4 × button

Operating conditions	R-KF-0500T R-KF-0400T
Operation temperature	-20 ÷ +55 °C
Storage temperature	-30 ÷ +70 °C

Dimensions and weight	
Dimensions	70 × 42 × 15 mm
Weight	8 g

Power supply	R-KF-0500T R-KF-0400T
Power supply	CR2032 lithium battery
Battery lifetime	about 2 to 4 years (according to frequency of using)

### Order number

TXN 132 08	R-KF-0500T, RF, key rings, 5 buttons
TXN 132 35	R-KF-0400T, RF, key rings, 4 buttons

Type	DI	RO	AI	AO	Comm
<b>R-HM-1113M</b>	8	11	3	2	RFox
<b>R-HM-1121M</b>	8	19	3	2	RFox

## Basic features

- Modules on DIN rail with combination of analog and digital inputs and outputs.
- Each module has at wireless bus RFox only one address.
- 3 analog inputs for Resistance Temperature Detectors (RTD) and 2 analog outputs 0 – 10V use for 1 – 2 regulation loops for example heating, cooling or for general use.
- 8 independent inputs for voltage free contacts.
- R-HM-1113M contains 4 galvanic isolated groups for 5 A and 1 power relay for 16 A with independent NO contact. Each group may be used independently for switching 24 V DC or 230 V AC in different phases.
- R-HM-1121M contains 6 galvanic isolated groups for 5 A and 3 power relays for 16 A with independent switching contact. Each group may be used independently for switching 24 V DC or 230 V AC in different phases.
- Power relays for 16 A have contacts with combination wolfram/AgSnO2 for reliable switching of high loads.
- Each relay is independently addressed and controlled from program.
- After pushing button MANUAL CONTROL we can each relay independently with appropriate button.
- Status of digital inputs, relay outputs, mode „MANUAL CONTROL“ and operation is indicated by LED diode at front part of module.

## Connection

- Modules communicate in wireless network RFox. HW address (4 hexadecimal digits) is stated at front panel.
- Modules are connected into master of RFox network by pairing process.
- Module R-HM-1113M has internal antenna, module R-HM-1121M has connector for connection of external antenna. During installation we have to take into account local conditions for radio signal transmitting.
- Module R-HM-1113M is supplied from 24 V DC, module R-HM-1121M is supplied from power supply 230 V AC.
- Inputs and outputs are connected via removable connectors, power outputs of R-HM-1121M via firm terminals.

## Use

- Modules are used for large installation centralized into switchboard. Typically for one hotel room, one room or residential house floor.
- Switching loads of R, L or C type, independent outputs specially designed for switching power circuits especially inductive and capacitive loads.
- Control of circuits in rooms: sockets circuits, lighting, жалousies, heating and ventilation.
- Regulation of solar and combined systems of heating



R-HM-1113M



R-HM-1121M

## Connection example

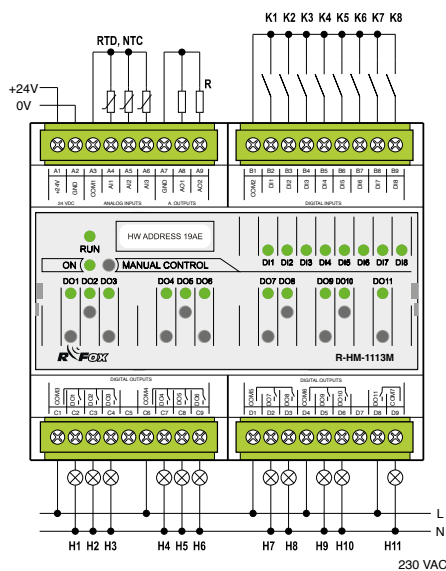

R-HM-1113M

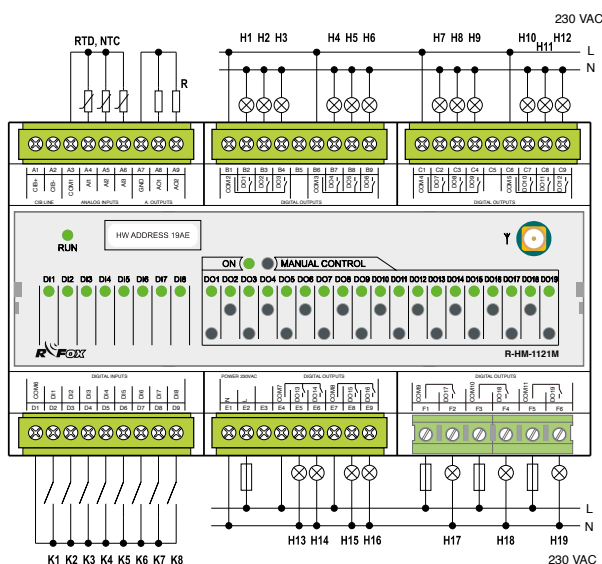

R-HM-1121M

## Communication

	R-HM-1113M	R-HM-1121M
Wireless bus	RFox	RFox
Antenna	Integrated	External, optional
Frequency	868 MHz	868 MHz
Signal transmission	Both directions with confirmation	Both directions with confirmation
Range	About 30m in buildings, 300m in empty space	About 30m in buildings, 300m in empty space
Interval of transmitting		

Analog inputs	R-HM-1113M	R-HM-1121M
Number of inputs	3	3
Common wire	REF	REF
Galvanic isolation	no	no
Resolution	12 bit	12 bit
Measurement ranges		
RTD	Pt1000, Ni1000	Pt1000, Ni1000
NTC (thermistor)	12 kΩ, optionally 5 up to 20 kΩ	12 kΩ, optionally 5 up to 20 kΩ



R-HM-1113M

Analog outputs	R-HM-1113M	R-HM-1121M
Number of inputs	2	2
Common wire	Minus (GND)	Minus (GND)
Galvanic isolation	no	no
Resolution	8 bit	8 bit
Output range	0÷10 V, 1÷10 V	0÷10 V, 1÷10 V



R-HM-1121M

Digital inputs	R-HM-1113M	R-HM-1121M
Input type	8× voltage-free contact	8× voltage-free contact

Relay outputs	R-HM-1113M	R-HM-1121M
Number of outputs×groups	Total 11 2×3 relay 5 A 2×2 relay 5 A 1×relay 16 A	Total 19 4×3 relay 5 A 2×2 relay 5 A 3×1 relay 16 A
Galvanic isolation	Yes (even groups each other)	Yes (even groups each other)
Switched voltage	min. 5 V DC; 24 V DC; max. 250 V AC	min. 5 V DC; 24 V DC; max. 250 V AC
Group relay outputs	DO1 ÷ DO3, DO4 ÷ DO6, DO7 ÷ DO8, DO9 ÷ DO10	DO1 ÷ DO3, DO4 ÷ DO6, DO7 ÷ DO9, DO10 ÷ DO12, DO13 ÷ DO14, DO15 ÷ DO16
Switched current	min. 100 mA; max. 5 A	min. 100 mA; max. 5 A
Peak current	5 A/<3 s	5 A/<3 s
Time of switching on/off contact	typ. 10 ms/4 ms	typ. 10 ms/4 ms
Current through joint terminal	10 A	10 A
Switching frequency without load	max. 300 min <sup>-1</sup>	max. 300 min <sup>-1</sup>
Switching frequency with nominal load	max. 20 min <sup>-1</sup>	max. 20 min <sup>-1</sup>
Mechanical/Electrical lifetime at maximal load	5×10 <sup>6</sup> /1×10 <sup>5</sup>	5×10 <sup>6</sup> /1×10 <sup>5</sup>
Short-circuit protection	no	no
Spike suppressor of inductive load	External (RC member, varistor, diode)	External (RC member, varistor, diode)
Insulation voltage between each relay outputs	3750 V AC	3750 V AC
Connection/Conductors cross-section	Removable connector/max. 2.5 mm <sup>2</sup>	Removable connector/max. 2.5 mm <sup>2</sup>
Relay outputs independent	DO11	DO17, DO18, DO19
Switched current	16 A	16 A
Peak current	160 A/<10 ms	160 A/<10 ms
Time of switch on/off contact	max. 10 ms/4 ms	max. 10 ms/4 ms
Minimal switched current	100 mA	100 mA
Switching frequency without load	max. 60 min <sup>-1</sup>	max. 60 min <sup>-1</sup>
Switching frequency with nominal load	max. 6 min <sup>-1</sup>	max. 6 min <sup>-1</sup>
Mechanical/Electrical lifetime at maximal load	3×10 <sup>6</sup> /1×10 <sup>5</sup>	3×10 <sup>6</sup> /1×10 <sup>5</sup>
Short-circuit protection	No	No
Spike suppressor of inductive load	External (RC member, varistor, diode)	External (RC member, varistor, diode)
Insulation voltage between each relay outputs	3750 V AC	3750 V AC
Connection/Conductors cross-section	Firm terminals/max. 4 mm <sup>2</sup>	Firm terminals/max. 4 mm <sup>2</sup>

Operating conditions	
Operating temperature	0 .. +55 °C
Storage temperature	-30 .. +70 °C
Electric strength	according EN 60950
IP Degree of protection IEC 529	IP 20, IP40 with cover in switchboard
Overvoltage category	III
Degree of pollution IEC EN 60664-1:2004	2
Working position	any
Installation	on DIN rail

Dimensions and weight	R-HM-1113M	R-HM-1121M
Dimensions	90×105×65 mm	90×156×65 mm
Weight	161 g	440 g

Power supply	R-HM-1113M	R-HM-1121M
Input nominal voltage (SELV)	+24 – 27.2 V DC	230 V AC
Nominal load	160 mA	35 mA

Order number	
TXN 132 10	R-HM-1113M – RFox – combined module 3×AI, 8×DI (contact), 2×AO, 10×RO 230 V 5 A, 1×RO 230 V 16 A
TXN 132 11	R-HM-1121M – RFox – combined module 3×AI, 8×DI (contact), 2×AO, 16×RO 230 V 5 A, 3×RO 230 V 16 A

Type	DI	DO	AI	AO	Comm
<b>R-IB-0400B</b>	4				RFox

## Basic features

- Module with 4 inputs for sensing device with output voltage-free contact.

## Connection

- Module is designed as standard device of data radio network RFox.
- Mechanical design suitable for built-in into standard installation box.
- Recommended installation position vertical, according to sign on the cover.

## Use

- Connection of contact switches in any design, any sensors, signalling their status by voltage-free contact, especially security and safety sensors etc.

## Connection example

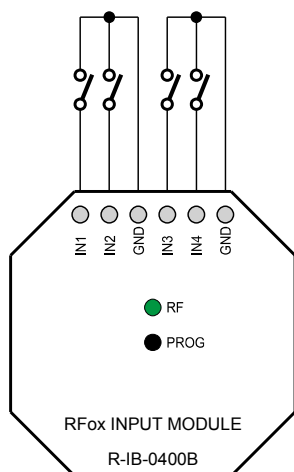

## Digital inputs

Number of inputs	4 x voltage-free contact, with common terminal
Input resistance for switching on	Max. 100 Ω
Input resistance for switching off	Min. 20 kΩ

## Communication RFox

Frequency	868.35 MHz
Signal transmission	Both directions with confirmation
Range	About 30m in building, 100m in empty space <sup>1)</sup>
Range of transmitting	10 min without input activation, immediately with input activation

<sup>1)</sup> range depends on type of building construction materials and type of installation. To extend the range of communication there is mesh technology available.

## Operating conditions

Operation temperature	0 ÷ +70 °C
Storage temperature	-30 ÷ +70 °C
Electric strength	according EN 60950
IP Degree of protection IEC 529	IP 20
Degree of pollution IEC EN 60664-1:2004	2
Working position	vertical, according to sign on the cover
Installation	into installation box under plaster

## Dimensions and weight

Dimensions	49 x 49 x 25 mm
Weight	30 g

## Power supply

Power supply	½AA lithium battery ER14250M
Battery lifetime	about 2 years (according to frequency of switching)
Battery diagnostics	Yes

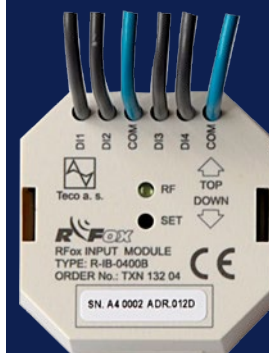

R-IB-0400B

## Order number

TXN 132 04 R-IB-0400B, RFox, 4 x DI, voltage-free contact, box, battery



Type	DI	DO/RO	AI	AO	Comm
<b>R-OR-0001B</b>		1 x RO			RFox

## Basic features

- Module with one switching relay contact for power loads at 230 V AC.
- Power supply from 230 V AC. Wireless communication.
- Modules are designed for switching independent loads/devices by relay output.
- Relay is independently addressed and wireless controlled by central module via sending commands with confirmation.

## Connection

- Module is designed as standard device of data radio network RFox.
- Mechanical design suitable into standard installation box.
- Recommended installation position vertical, according to sign on the cover.

## Use

- Used for switching the loads at 230 V AC, where we need to replace wire bus communication by wireless connection.
- During projection we have to calculate load of contact and their protection at different type of load.

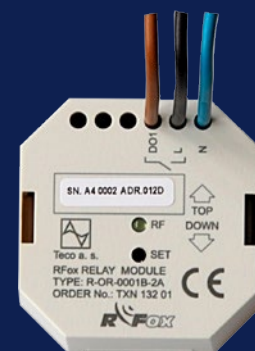

R-OR-0001B

## Connection example

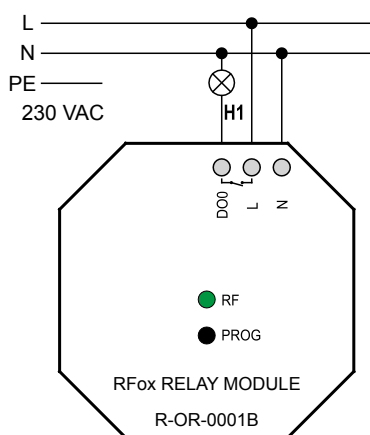

## Relay outputs

	R-OR-0001R
Number of inputs	1 x relay
Load	230 V AC, 50 Hz, 16 A resistance load, Relay contact switches phase L on module output

## Communication RFox

Frequency	868.35 MHz
Signal transmission	Obousměrný s potvrzením
Range	About 30m in building, 100m in empty space <sup>1)</sup>

<sup>1)</sup> range depends on type of building construction materials and type of installation. To extend the range of communication there is mesh technology available.

## Operating conditions

Operation temperature	0 ÷ +70 °C
Storage temperature	-30 ÷ +70 °C
Electric strength	according EN 60950
IP Degree of protection IEC 529	IP 20
Overvoltage category	II
Degree of pollution IEC EN 60664-1:2004	1
Working position	vertical, according sign at the cover
Installation	into installation box

## Dimensions and weight

Mechanical construction	Plastic modul on installation box
Dimensions	49 x 49 x 25 mm
Weight	45 g

## Power supply

Power supply voltage	230 V AC, 50 Hz
Power cable	full Cu cable, length 120 mm, connecting diameter 2.5 mm <sup>2</sup>
Power supply protection	Circuit breaker 16 A, specification B
Typ. power	2.8 W
Max. power	4.6 W

## Order number

TXN 132 01 R-OR-0001B, RFox, 1 x Relay 16 A, NO contact, box

# Power Supplies

230 V AC/24 V DC or 27,2 V DC



PS2-60/27



DR-15-24  
24 V DC



DR-60-24  
24 V DC



24 V DC  
DR-100-24



PS-25/24  
24 V DC



PS-50/24  
24 V DC



PS-50/27  
27.2 V DC



PS-100/24  
24 V DC



PS-100/27  
27.2 V DC

# Power supply with two level outputs

Type	Input voltage	Output voltage	Output current		
<b>PS2-60/27</b>	230 V AC	27.2 V DC 12 V DC	2.3 A 0.3 A		

## Basic features

- PS2-60/27 module is switching power supply with 2 levels of fixed output voltage 27.2 V DC and 12 V DC.
- It is designed for supplying control system Foxtrot with backup accumulators.
- The design of output circuits enables to connect the pair of backup accumulators which are charged directly from the power supply.
- The other level 12 V DC is for supplying security sensors.
- The high efficiency eliminates the need of active cooling.

## Connection

- Compact form-factor for DIN rail mounting (6 modules width) for standard circuit breaker cabinets.
- All circuits are connected by screw terminals.

## Use

- Power supply for basic and expansion modules of Foxtrot system.
- Together with modules C-B-0001M and pair of backup accumulators can supply all CIB based installations.



PS2-60/27

## Connection example

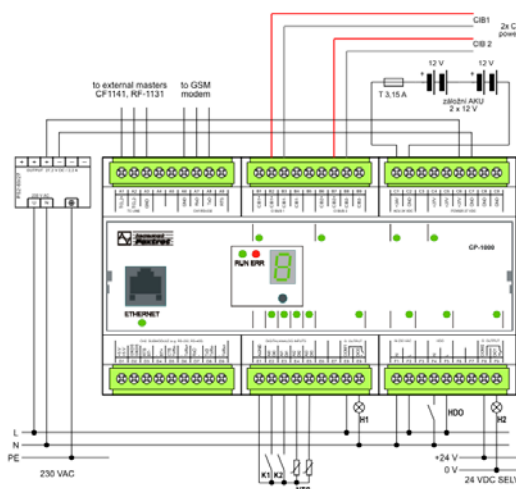
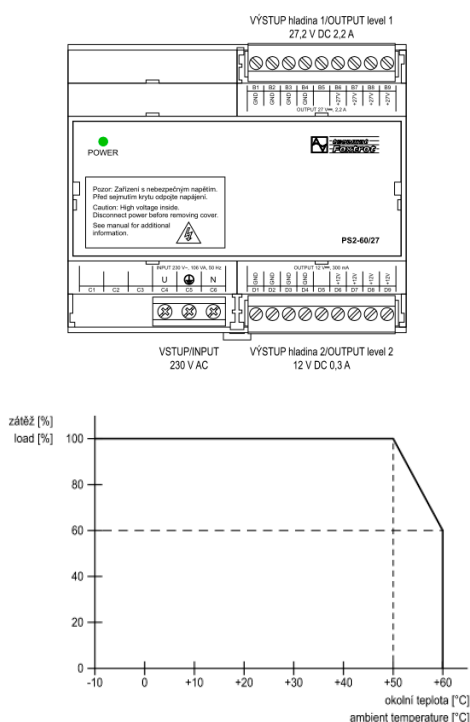

## Operating conditions

Operating temperature	-10 .. +60 °C
Storage temperature	-40 .. +85 °C
Electric strength	according EN 60950
Class of electrical device protection	I according IEC EN 61140
IP Degree of protection(IEC 529)	IP 20, IP40 covered in switchboard
Overvoltage category IEC EN 60664-1	II
Degree of pollution IEC EN60664-1:2008	2
Working position	vertical
Installation	on DIN rail
Connection	screw terminals
Conductors cross-section	Max. 2m,5 mm <sup>2</sup>

## Dimensions and weight

Dimensions	90×105×65 mm (6M)
Weight	340 g

## Power supply

Input voltage	230 V AC, -15 up to 25%
Min. input voltage	110 V AC/output voltage less 45 W
Input voltage frequency	47 – 63 Hz
Max. input power	106 VA
Input fuse	T2.5/250 V
Output	
Current output – range	0.48 A/230 VAC
Level 1; Output voltage/current	27.2 V DC/0 – 2.2 A
Level 2; Output voltage/current	12 V DC/0 – 0.3 A
Max.total output power	60 W
Efficiency	87 %
Short-circuit protection	Electronic
Electrical resistance of isolation	3000 V AC
Galvanic isolation input/output	Yes

## Order number

TXN 070 40 PS2-60/27 power supply 230 VAC/27.2 V DC, 2.2 A; 12 V DC, 0.3 A

Type	Input voltage	Input voltage	Input current		
<b>DR-60-15</b>	230 V AC	24 V DC	0.63 A		
<b>DR-60-24</b>	230 V AC	24 V DC	2.5 A		
<b>DR-60-100</b>	230 V AC	24 V DC	4.2 A		

### Basic features

- Family of power supplies 24 V DC on DIN rail.
- Input voltage in wide range 100–240 V AC
- Output voltage may be tuned by trimmer  $\pm 10\%$
- Electronic short-circuit protection, overload and overvoltage
- Cooling by nature circulation of air.
- Certifikace UL, CUL, TUV, CB, CE

### Connection

- Primary and secondary voltage is connected with screw terminals.

### Use

- Basic (non back-up) power supply of Foxtrot system
- Power supply of basic and expansion modules
- Basic power supply of CIB bus in coordination with module of impedance adaptation C-BS-0001M

### Connection example

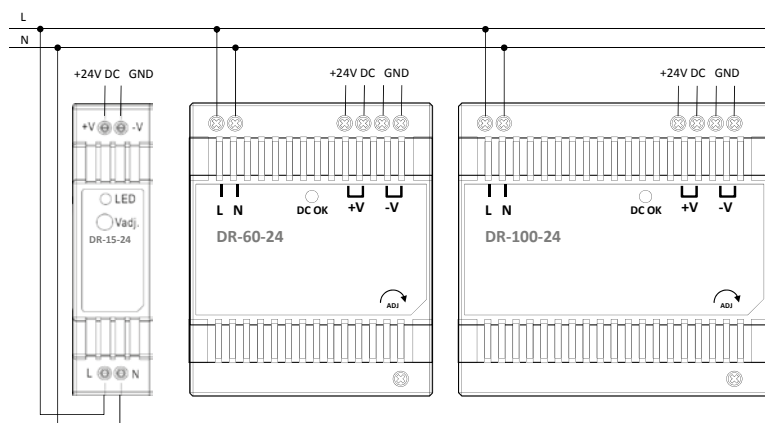

DR-15-24



DR-60-24



DR-100-24

### Operating conditions

Operating temperature	-20 .. +45 °C
Storage temperature	-40 .. +84 °C
Electric strength	according EN 60950
IP Degree of protection (IEC 529)	IP20 with cover in the cabinet
Overvoltage category	II
Degree of pollution IEC EN60664-1:2008	2
Working position	any
Installation	into switchboard on DIN rail
Connection	screw terminals

### Dimensions and weight

	DR-15-24	DR-60-24	DR-100-24
Dimensions	25 x 93 x 56 mm (1.5M)	78 x 93 x 56 mm (4M)	100 x 93 x 56 mm (5.7M)
Weight	100g	300g	350g

### Power supply

	DR-15-24	DR-60-24	DR-100-24
Input voltage – range	100–240 V AC, 47–63 Hz	100–230 V AC, 47–63 Hz	100–230 V AC, 47–63 Hz
Input current – range	0.48 A/230 VAC	1.2 A/115 VAC, 0.8 A/230 VAC	3 A/115 VAC, 1.6 A/230 VAC
Output voltage	24 VDC	24 VDC	24 VDC
Tuning of output voltage	$\pm 10\%$	$\pm 10\%$	$\pm 10\%$
Output current	0.63 A	2.5 A	4.2 A
Max. permanent output power	15.2 W	60 W	100 W
Short-circuit protection	Electronic	Electronic	Electronic
Electrical resistance of isolation	3000 VAC	3000 VAC	3000 VAC
Galvanic isolation input/output	Yes	Yes	Yes

### Order number

DR-15-24	DR-15-24 Power supply 230 VAC/24 VDC, 0.63 A
DR-60-24	DR-60-24 Power supply 230 VAC/24 VDC, 2.5 A
DR-100-24	DR-100-24 Power supply 230 VAC/24 VDC, 4.2 A

# Power supply 24 and 27.2 V DC, single-level

Type	Input voltage	Output voltage	Output current		
<b>PS-25/24</b>	230 V AC	24 V DC	1 A		
<b>PS-50/24</b>	230 V AC	24 V DC	2 A		
<b>PS-100/24</b>	230 V AC	24 V DC	4 A		
<b>PS-50/27</b>	230 V AC	27.2 V DC	1.75 A		
<b>PS-100/27</b>	230 V AC	27.2 V DC	3.5 A		

## Basic features

- Family of power supplies 24 V DC on DIN rail.
- Input voltage in 230 V AC/50Hz
- Indication of operation by LED diode
- Electronic protection of outputs against short circuit.
- Cooling by nature circulation of the air.

## Connection

- Primary and secondary voltage is connected with screw terminals.

## Use

- Version 24 V DC – basic (non back up) power supply of system Foxtrot.
- Version 27.2 V DC – back up power supply with charging the batteries.
- Power supply of basic and expansion modules.
- Basic power supply of CIB bus in coordination with module of impedance adaptation C-BS-0001M.

## Connection example



PS25/24



PS50/24



PS50/27

## Operating conditions

Operating temperature	-10 .. +55 °C
Storage temperature	-40 .. +85 °C
Electric strength	according EN 60950
IP Degree of protection (IEC 529)	IP20
Overvoltage category	III
Degree of interference	Class B according IEC EN 550 11
Degree of pollution IEC EN60664-1:2008	2
Working position	Any
Installation:	into switchboard on DIN rail
Connections	screw terminals

## Dimensions and weight

	PS-25/24	PS-50/24	PS-100/24	PS-50/27	PS-100/27
Dimensions	148 x 85 x 57 mm	148 x 85 x 57 mm	148 x 85 x 57 mm	177 x 105 x 54 mm	177 x 105 x 54 mm
Weight	510 g	510 g	510 g	700 g	700 g

## Power supply

	PS-25/24	PS-50/24	PS-100/24	PS-50/27	PS-100/27
Nominal input voltage	230 V AC, 50Hz	230 V, 50Hz	230 V AC, 50Hz	230 V AC, 50Hz	230 V AC, 50Hz
Input power	0.48 A/230 VAC	92 VA	185 VA	92 VA	185 VA
Efficiency		80%	85%	80%	85%
Output voltage	24 V DC ±3%	24 V DC ±3%	24 V DC ±1%	27.2 V DC ±1%	27.2 V DC ±1%
Output current	1 A	2 A	4 A	1.75 A	3.5 A
Maximal permanent output power	25 W	50 W	100 W	50 W	100 W
Protection against short circuit	Electronic	Electronic	Electronic	Electronic	Electronic
Electrical resistance of isolation	3700 V AC/50Hz	3700 V AC/50Hz	3700 V AC/50Hz	3700 V AC/50Hz	3700 V AC/50Hz
Galvanic isolation input/output	Yes	Yes	Yes	Yes	Yes

## Order number

TXN 070 22	PS-25/24 Power supply 230 VAC/24 VDC, 1 A
TXN 070 10	PS-50/24 Power supply 230 VAC/24 VDC, 2 A
TXN 070 15	PS-100/24 Power supply 230 VAC/24 VDC, 4 A
TXN 070 21	PS-50/27 Power supply 230 VAC/27.2 VDC, 1.75 A
TXN 070 16	PS-100/27 Power supply 230 VAC/27.2 VDC, 3.5 A



PS100/24



PS100/27



Type	TC700	Foxtrot	Foxtrot basic module	SoftPLC
<b>Mosaic Lite+</b>			CP-100x without communication module	Yes
<b>Mosaic Compact+</b>		Yes	Yes	Yes
<b>Mosaic Profi+</b>	Yes	Yes	Yes	Yes

### Basic features

- Mosaic is development software for creating and debugging programs for programmable systems Tecomat. Software is developed according to international standards IEC EN 61131-3, what defines structure of programs and programming languages for PLC.
- All in one package.

- Lite version for testing and training.
- Full version protected by HW key – portable licence.
- Regular update.
- Language mutations – czech, english, deutsch, russian, polish.
- For Windows XP, Vista, Windows 7 and Windows 8 – 32 bit and 64 bit.

### Programming

- Mosaic enables to program all PLC delivered by company Teco.
- Programming according to standard IEC EN 61131-3 – graphic languages LD (relay logic) and FBD (function blocks), CFC (continuous function chart) and text languages ST (structured text) and IL (instruction language).
- Basic element of program is POU (program unit) – function, function block or program.
- Graphic languages offer easy and intuitive program creation.
- IEC assistant – tool for program support in text languages.
- Possibility to combine different types of languages.
- Common declaration part for all types of languages.
- Standard and user data types including structures and fields.
- Standard and user function libraries and function blocks are available.

### IEC project manager

- Declaration of all program elements for PLC.
- Standard and user libraries management.
- Well-arranged visualization in structures.

### Inspector POU

- Tool for all parts PLC program debugging.
- Visualization of input and output variables POU statuses and running of program.
- Visual differentiation of logic variables in graphic languages.
- Dynamic (on-line) or static program monitoring (calculation of POU is captured in buffer).
- Debugging points, setting conditions for run tracing.

### PanelMaker – tool for operator panels

- Tool for creation of dialogs for operator panels from Teco production line.
- Program for panel is created directly in Mosaic and becomes a part of program for PLC.
- Visualize and edit is possible for all global variables.

### SimPLC – simulator PLC

- Built-in simulator PLC – debugging without connection of real hardware.
- Possibility to simulate all PLC Tecomat.
- Mosaic can work as data server for visualization programs – support for visualization debugging.

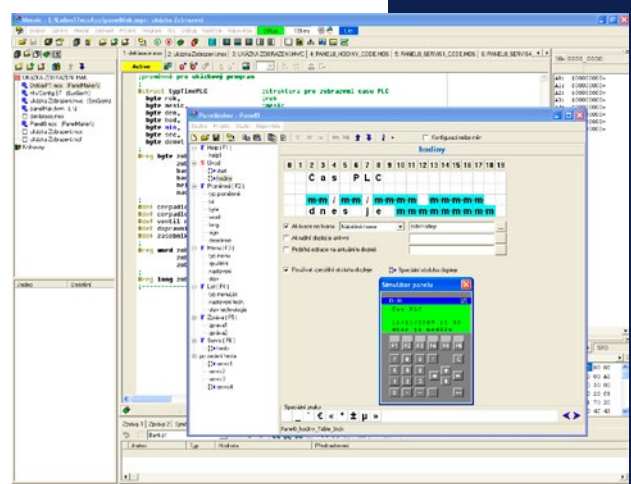
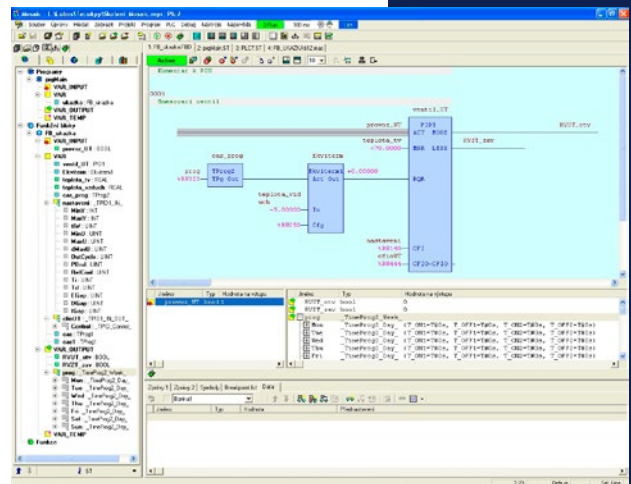
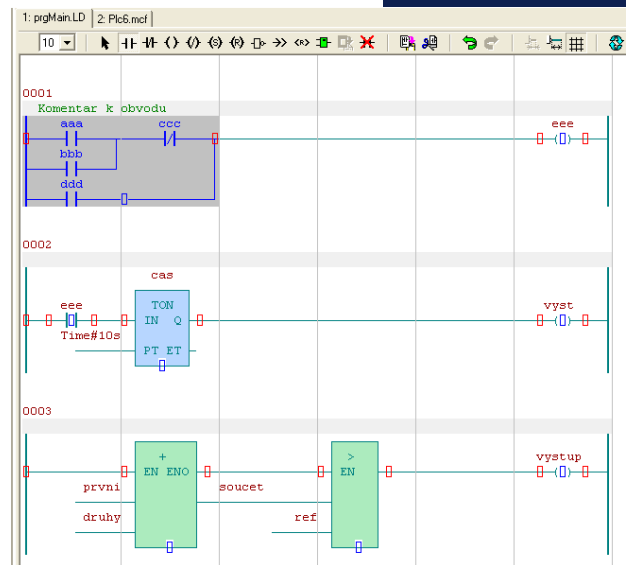

## GPMaker – tool for graphic operator panels

- Screen editor of graphic panel ID-17.
- Programming of panel without exports and imports into other programs.
- Access to any variable of any type.
- Static and dynamic texts and images.
- Text manager – enables to use multi language texts and choose language for display.
- Font manager – possibility to import own fonts and symbol sets.
- User defined buttons for each screen.

## PanelSim – operator panel simulator

- Dialog debugging created by PanelMaker without connection of operator panel. We may simulate alphanumeric panels from Tecno production line.
- All functions of panel are simulated on PC.
- It can be used with real PLC or with simulated PLC.

## On-line change of PLC program

- PLC program change without stopping the controlled technology.
- Enables to do any change in program without loss of present operated data.
- Very fast switching between old and new program.
- Minimization of data losses caused by shutdown of control system because of maintenance SW and HW of PLC.

## WebMaker – tool for web pages designing for web server of PLC Tecomat

- Graphic tool for creation of web pages for systems Tecomat Foxtrot and TC700.
- Generated code in XML language is connected directly on variables in PLC.
- Web pages enables not only visualize, but also to control technology.
- We can input texts, static and dynamic images, bar graphs, images from IP cameras into web pages.
- Image manager enables to add own images
- Different levels of administrative accesses.

## GraphMaker – tool for monitoring of process variables

- Monitoring of process up to 16 variables of all types in real time.
- Measured data we can store at hard disc, print, export to other programs (Excel etc.) or directly analyze.
- Two cursors for reading data, zoom, different visualization of read data, setting sample period.
- Function of logic analyzer – read data are stored into buffer in CPU and after loading transferred into GraphMaker tool.
- Data storing may be conditioned by fulfilling of logic condition (function TRIG).
- Data may be stored in each calculation cycle.

## PIDMaker – tool for defining and monitoring of regulation loops

- Visualization superstructure of regulation instructions PID implemented in PLC.
- Easy implementation, debugging and managing of regulation algorithms.
- Interactive view of regulation process, facilitating correct setting of regulator parameters.
- Setting and correcting of regulation parameters in real time, during the regulation. Simulation of simple technology processes on PC part (linear system of complexity up to 3rd order with possibility to simulate traffic delay). Simulation do not change user program implemented into real technology.

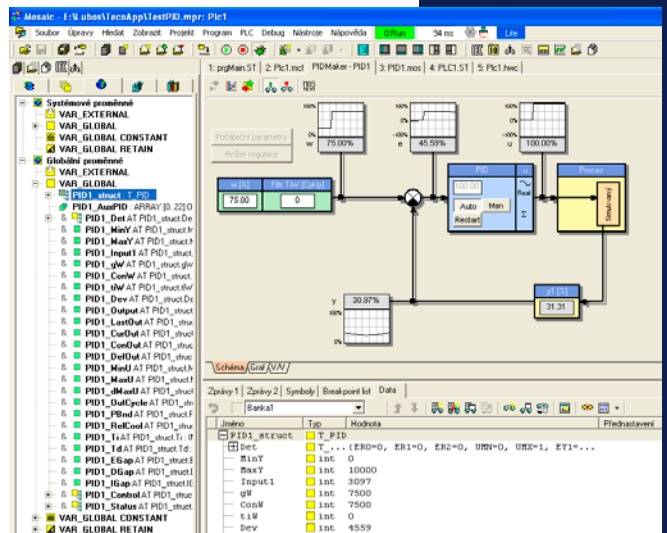
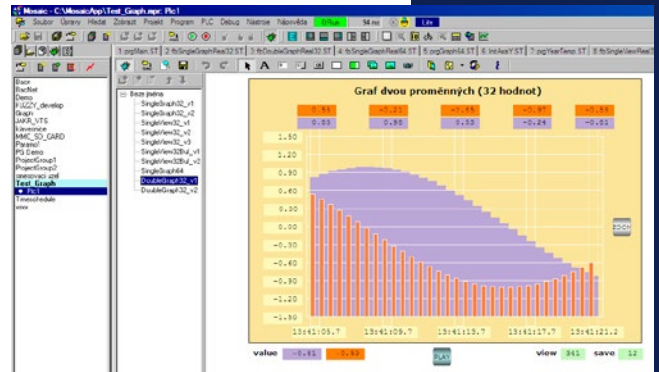
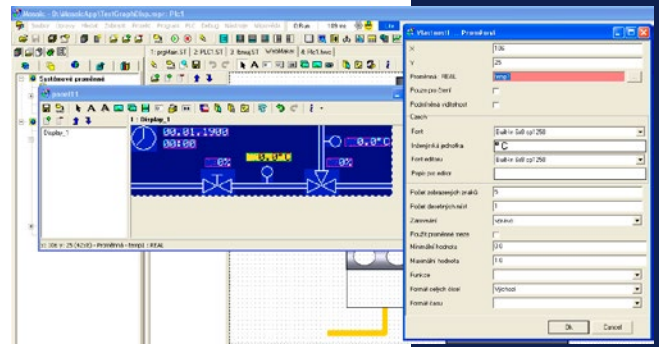

## Datalogger – tool for storing data into file

- Data are stored into csv files at memory card.
- One datalogger can contain up to 4 collections per 16 signals.
- Values are stored periodically (periodical collection) or on the basis of any event (event collection).
- Third type is signal collection, where signals are stored independently on others.
- Values are stored with time sign.
- Data storing can be controlled from user program, for example from interface in web pages.
- Values from csv files can be read and visualized by GraphMaker tool.

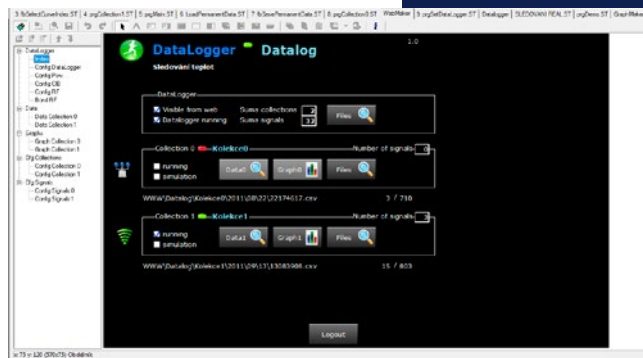

## SelectPLC – hardware configuration

- Choosing of PLC type and easy defining of PLC configuration.
- Manual configuration by filling in easy table or automated reading from connected PLC.
- Each module has own form for configuration.
- Browser of present status of all variables of each modules including communication channels.
- Possibility to fix firm value of inputs and outputs independent on user program and neighborhood – simulation of inputs excitation at user program debugging and easy control of connection actuators with outputs.

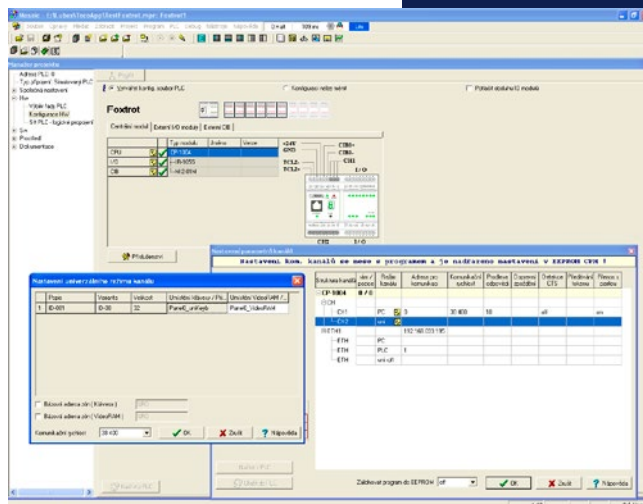

## NetPLC – PLC network definition

- Easy defining of communication in PLC network, connection of operator panel at serial line or connection of external devices with standard protocols (PROFIBUS DP, Modbus, CAN).

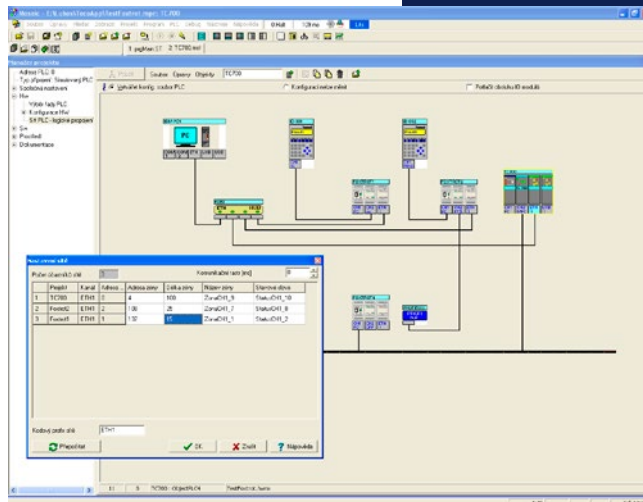

## Function blocks libraries

- FileLib – library for work with files at memory card.
- DataboxLib – work with internal memory Databox.
- FlashLib – data storing into internal flash memory.
- GSMLib – library for receiving and transmitting SMS messages.
- ComLib – receiving and transmitting of messages via ethernet and serial line.
- InternetLib – library of internet network services – SMTP, SNTp, http
- ModbusRTULib – communication by protocols Modbus RTU and Modbus TCP master
- BACnetLib – communication by protocol BACnet
- BuildingLib – library of functions for BMS
- RegoLib – library for regulation – regulators, time programs, errors history, signalling errors history.
- RexLib – library for advanced regulation.
- ModelLib – library for modelling.
- MotionControl – library for positioning.
- ToStringLib – converting of data to strings.
- CRCLib – calculation of checksum.
- SysLib – system functions.

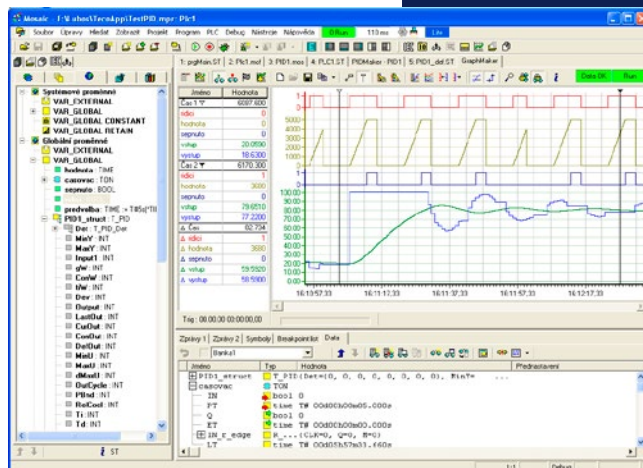



## Motion sensors

Type	DI	DO	AI	AO	Comm
<b>Detectors of security systems, sirenas</b>					

### Basic features

- Detectors are designed as specialised sensors of these values or events, whose are directly related with disruption or threat of secured space.
- Units give binary information about monitored value/event status and it can be used for making alarm in case of monitoring the space.
- In space controlled by system Foxtrot we may use these signals in situation where the space is unlocked and these detectors give us useful information for further automated actions.
- Mostly we use motion sensors and sensors of open windows/doors.

### Connection

- Detectors are power supplied from 12 V DC.
- On CIB bus we connect them to connect detectors with balanced input.
- Siren may be connected at selected output relay in the system, which is assigned in software with functions of alarm output.

### Use

- Complete building automation system with specialised detectors of events related with space security, which may be used for further actions for heating and lighting.

### Specification

JS-20 LARGO	Motion detector
Detection distance	12 m
Power supply	12 V DC/35 mA
Operating temperature	-10 ÷ +55 °C
Installation	On flat area
Diameter of connecting wires	1 mm <sup>2</sup>
Dimensions	110×60×55 mm
Weight	120 g

### Specification

GBS-210 VIVO	Broken glass detector
Detection distance	< 9 m
Power supply	12 V DC/35 mA
Operating temperature	-10 ÷ +55 °C
Installation	On flat area
Diameter of connecting wires	1 mm <sup>2</sup>
Dimensions	100×40×23 mm
Weight	120 g

### Specification

SA-200	Doors magnetic detector
Detection distance	15 mm
Installation	On flat area
Diameter of connecting wires	1 mm <sup>2</sup>
Dimensions	35×15×9 mm
Weight	30 g

### Specification

SD-212SP	Optical smoke detector
Power supply	12 V DC/3 mA
Operating temperature	-10 ÷ +55 °C
Installation	On flat area
Diameter of connecting wires	1 mm <sup>2</sup>
Dimensions	120×120×40 mm
Weight	150 g

### Specification

GS-133	Detector of flammable gasses
Power supply	12 V DC/150 mA
Operating temperature	-10 ÷ +55 °C
Installation	On flat area
Diameter of connecting wires	1.5 mm <sup>2</sup>
Dimensions	100×120×40 mm
Weight	112 g

### Specification

SA-913	SA-913 Interior piezzo-siren
Sound intensity	110 dB/m
Power supply	12 V DC/250 mA
Operating temperature	-10 ÷ +55 °C
Installation	On flat area
Diameter of connecting wires	1.5 mm <sup>2</sup>
Dimensions	120×72×40 mm
Weight	140 g

### Specification

SA-220	Crossing magnetic detector
Detection distance	75 mm
Dimensions	106×38×10 mm
Weight	230 g

### Order number

JS-20 LARGO	JS-20 LARGO, PIR motion detector
GBS-210 VIVO	GBS-210 VIVO, Dual broken glass detector
GS-133	GS-133, Flammable gasses detector, power supply 12 VDC
SD-212SP	SD-212SP, Optical smoke detector with relay output and power supply 12 VDC
SA-200A	SA-200A, Magnetic contact with terminals 49×14×13 mm
SA-201A	SA-201A, Magnetic contact mini with led wire
SA-203	SA-203, Magnetic contact mini self-adhesive with led wires 33×8×9 mm
SA-220	SA-220, Magnetic metal crossing contact for metal gates with inputs in armored tube, 106×38×10 mm, working distance max. 75 mm
SA-913	SA-913 Interior piezzo-siren, white plastic
OS-365	OS-365, Outdoor back up magneto-dynamic siren including NiCd accumulator 4.8 V 1.8 Ah, LED blinker



JS-20 LARGO



GBS-210 VIVO

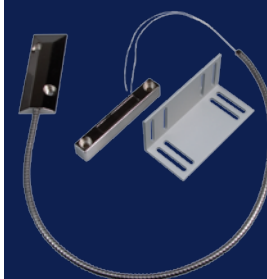

SA-200, SA-220



SD-212SP



GS-133



SA-913

Notes:







